



Firenzo Woodfires

The heart of a warm home

Please read this booklet and keep for future reference for the safe installation and operation of your:

Viking AG Dry

INSTALLATION AND OPERATION GUIDE



AG stands for Air Guard (Clean Air). This Fire can be installed on properties if less than 2 hectares of land and meets with ECAN standards of 0.9g and 68% efficiency.

AUTORISATION NUMBER 102465

This Fire must be installed by someone competent to do so, Firenzo recommend the use of a NZ Home Heating Association, solid fuel Fire installation technician (SFAIT), or other suitably qualified person. The Fire and Flue System must be installed in accordance with AS/NZS2918. All installations must be in accordance with these instructions. Consult with the building authority having jurisdiction to determine the need for a permit prior to commencing the installation. Failure to follow these instructions may also void your fire insurance and warranty.

This Fire has been tested to Appendix E & B of the joint Australia/New Zealand Standard 2918:2001.

This Fire conforms with ECAN Requirements.

INDEX

Page No:	Item No:	Topic:
3	1	Warnings
4	2	Installation Responsibilities
4	3	Floor Protector Requirements
5	4	Installation Clearances
6	5	Assembly Instructions
7	6	Flue Installation
8		Minimum Height of Flue Exit
9		Outside Air Kit Diagram
10		Outside Air Kit Installation
11	7	Operating Instructions
12		Operating Instructions
13	8,9,10	Operating Instructions
14	11	Operating Instructions
15	12	Warranties
16		Warranties
17		Warranties

Your Warranties Registration Card is enclosed, please complete and return to us.

Under our policy of continuous product improvement, Firenzo reserves the right to alter specifications or product from that shown.

1. WARNINGS

This Fire should be maintained and operated at all times in accordance with these instructions.

The **Viking Rural Dry** is tested to N.Z. Standards AS/NZS 2918:2001.

If this Fire is incorrectly installed a house fire may result. For your safety follow the installation instructions carefully.

Do NOT connect the Fire to a chimney serving another Fire.

Although the exterior of the Fire may appear cool, contact with the Fire may cause burns, warn children and others of the possibility of injury should they touch the Fire.

Do NOT dry clothing or unseasoned wood directly in contact with the Fire.

Keep all household combustible materials at least 600mm away from front of the Fire. This includes clothing, furniture, wood, newspaper, plastic, matches, etc.

DO NOT USE FLAMMABLE LIQUIDS or AEROSOLS in the vicinity of this Fire when it is operating.

Use caution when reloading with fuel. Do NOT attempt to load fuel into the Fire when the fire inside the stove is at or near its peak.

Do NOT burn large quantities of paper or combustible material that would create an extremely hot/quick fire.

Do NOT burn highly coloured paper or brochures (junk mail).

USE ONLY DRY WOOD (25% or less moisture content). AVOID BURNING WET OR GREEN WOOD.

The use of preservative treated wood as a fuel can be hazardous.

Timber treated with copper chromium and arsenic type preservatives will leave toxic residues in the ash, firebox or within the flue, timber offcuts from building construction will often contain boric salts. The combustion of this material over prolonged periods can produce adverse effects on refractory lining in solid fuel Fires. Emission of poisonous gases can also be experienced with the burning of treated wood.

Driftwood with salt content will also cause rapid deterioration of the Fire and should not be used.

2. INSTALLATION RESPONSIBILITIES

Warning: The Fire and Flue system shall be installed in accordance with AS/NZS 2918 and the appropriate requirements of the relevant building code or codes.

Any modification of the Fire that has not been approved in writing by the testing authority is considered to be in breach of the approval granted for compliance with AS/NZS 4013.

Caution: Mixing of Fire or Flue-system components from different sources or modifying the dimensional specification of components may result in hazardous conditions. Where such action is considered, the manufacturer should be consulted in the first instance.

Strict adherence to these instructions will meet these standards. Any variation from these installation instructions or any doubt about them must be checked against the requirements of the standards.

Please leave this manual with the owner when installation is complete.

3. FLOOR PROTECTOR REQUIREMENTS

The Fire should always be installed on top of its base due to high temperatures sustained over long periods. The base must be anchored to both the floor protector and the floor for seismic restraint. Anchor points are provided in the base.

If the Fire is installed on or within 500mm of a heat sensitive floor, **then an ash floor protector using a minimum of 6mm thick tiles will be required.** This floor protector shall extend under the Fire and not less than 300mm beyond the front of the fuel loading or ash removal openings. The width of the floor protector shall be not less than the width of the Fire, and shall extend not less than 200mm from each side of the fuel loading or ash removal openings unless it forms an abutment with a wall or heat shield at a lesser distance.

Where the floor protector consists of a number of components, it shall include a continuous layer of heat-resistant material extending under the Fire to the perimeter of the floor protector. All joints shall be fixed to prevent accidental separation, and shall be sealed to prevent any spilt ash or embers contacting any heat sensitive material.

4. INSTALLATION CLEARANCES

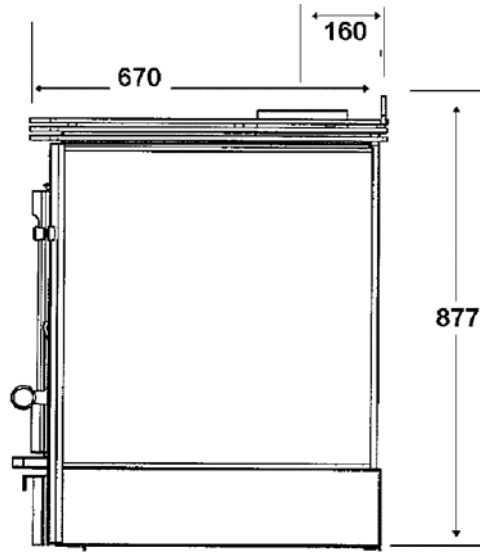
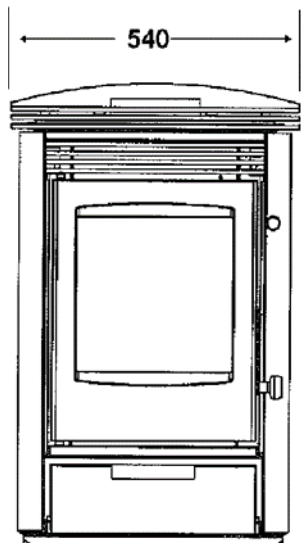

Internal Firebox Measurements: Height 340mm—Width 320mm—Depth 520mm

Flue Size: 150mm Heating Area estimate 200sqm

CLEARANCES	A	B	C	D	E	F	G	H	J	K	L	M	N	O
WITH FLUE SHIELD	100	320	300	120	50	260	590	350	780	1040	1280	1060	780	410

Clearances are in mm and are shown with an ash floor protector using 6mm ceramic tiles.

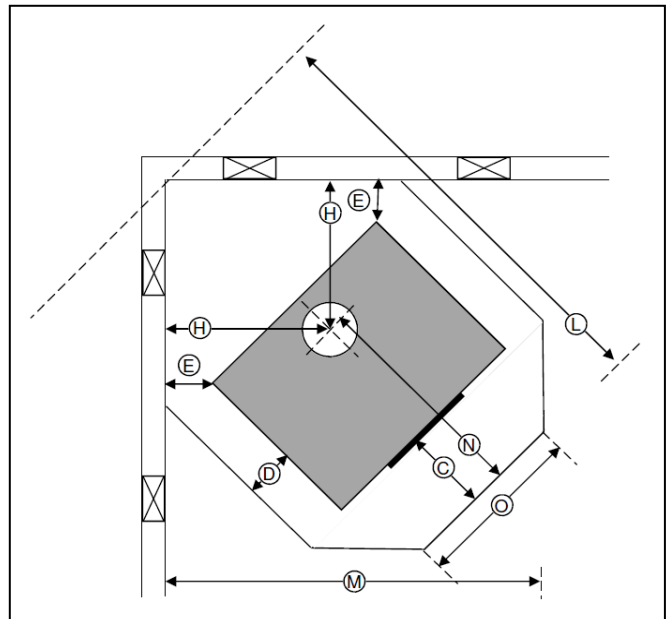
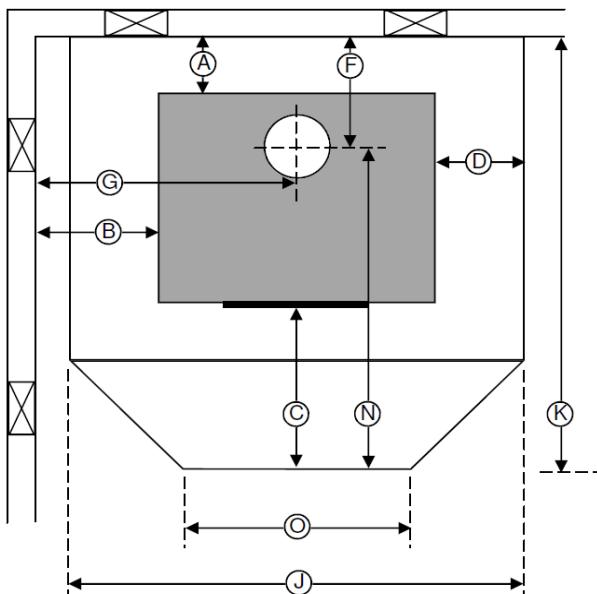

5. ASSEMBLY INSTRUCTIONS

1. Remove all outer packaging and timber.
2. Remove slotted steel top plates from rear of Fire and cast iron top plates from inside the Fire and carefully set aside, taking care not to scratch or damage the paint finishes.
3. Position Fire onto floor protector ensuring it complies with the clearances as shown in section 4 on page 5.

DO NOT ATTEMPT TO LIFT THE FIRE BY THE GRANITE ASHLIP.

4. Make sure the baffle bricks and the stainless steel flue gas deflectors are correctly sited.
5. Install the rear cast iron plate and then the front cast iron plate onto the rope seals around the top of the firebox and ensure they are bedded down well. Lifting lugs are positioned onto the sides of the casting, taking care not to catch fingers under the plates.
6. Assemble and install the flue as per instructions page 7 & 8.
7. A flue shield must be fitted; the minimum requirement is for a single skin, semi-circular, stainless steel flue shield with a reflective inner surface 1200mm high. This should be installed so that the bottom edge of the flue shield is 20mm from the top surface of the Fire and spaced off the flue by approximately 35mm.
8. Secure the fire to the floor by using 6-8mm Dyna Bolt fastenings through the holes provided in the rear of the base plate. This is a New Zealand Standard 2918 requirement due to NZ being earthquake prone.
9. Carefully position the main slotted steel painted top panel onto the Fire, there are locating lugs on the underside that fit into the indents on the cast iron tops that ensure it is correctly positioned. Slide in the rear infill top plate behind the flue and the curved top plate locates into the lugs onto the back edge.

6. FREESTANDING FLUE SYSTEM INSTALLATION INSTRUCTIONS

1. Position Fire on floor protector ensuring all Fire clearances are correct as per clearances on page 5.
2. Once the location is confirmed, the Fire and floor protector shall be fixed to the floor itself refer to page 4 & 5.
3. Extend a plumb line from the centre of the fire flue spigot to the ceiling. Mark position on ceiling and roof.
4. Trim hole and nog as required. Fix with non-combustible spacers and screws or clouts on all four sides.
5. Cut and frame (when required) an opening in the roof, position the outer casing through the roof until it is flush with the underside of the ceiling. Fix as in step 4.
6. Fix appropriate flashing around outer casing to the roof to ensure a weatherproof seal.
7. Assemble flue sections ensuring all seams are in line, the assembly is straight and crimped. Ends are pointing downwards. Fix each joint with three stainless rivets or self tapping screws.
8. Place ceiling plate with folded edges upwards over Flue spigot.
9. Position the flue into the Flue spigot. The flue can either be lowered from the top as a single unit or fed up from the room a length at a time, ensuring that all joints are fixed properly.
10. Slide the inner casing into place, between the outer casing and the flue.
11. The flue must extend 200mm above the outer casing.
NOTE: extra lengths of flue, inner and outer casing may be required to achieve the minimum clearance from the roof.
12. Slide top spacer over flue down into outer and inner casing and tighten.
13. Slide cowl over flue until it rests on spacer. Secure with rivets or self-tapping screws.
14. Fit Rain Hat. Do not fasten as it must be removable for flue cleaning.
15. Fix ceiling plate to ceiling maintaining an even gap all around the flue. NOTE: Ensure ceiling plate is spaced off from the ceiling with ceramic spacers supplied.

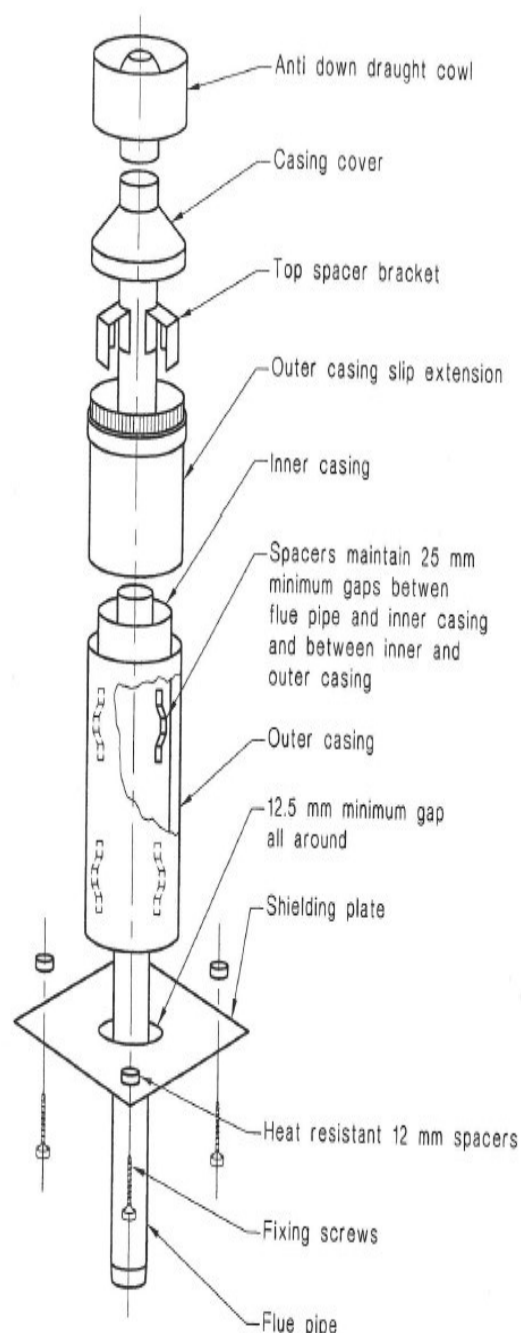

WARNING: The Fire and Flue System shall be installed in accordance with AS/NZS 2918:2001 Appendix F and the appropriate requirements of the relevant building code or codes. Firenzo/SFP Flue Kits or Davin Flue Kits must be used.

CAUTION: Mixing of fire or flue system components from different sources or modifying the dimensional specifications of components using more than 1 metre of extra flue may result in hazardous conditions. Where such action is considered the manufacturer should be consulted in the first instance.

FLUE SYSTEM MINIMUM HEIGHT

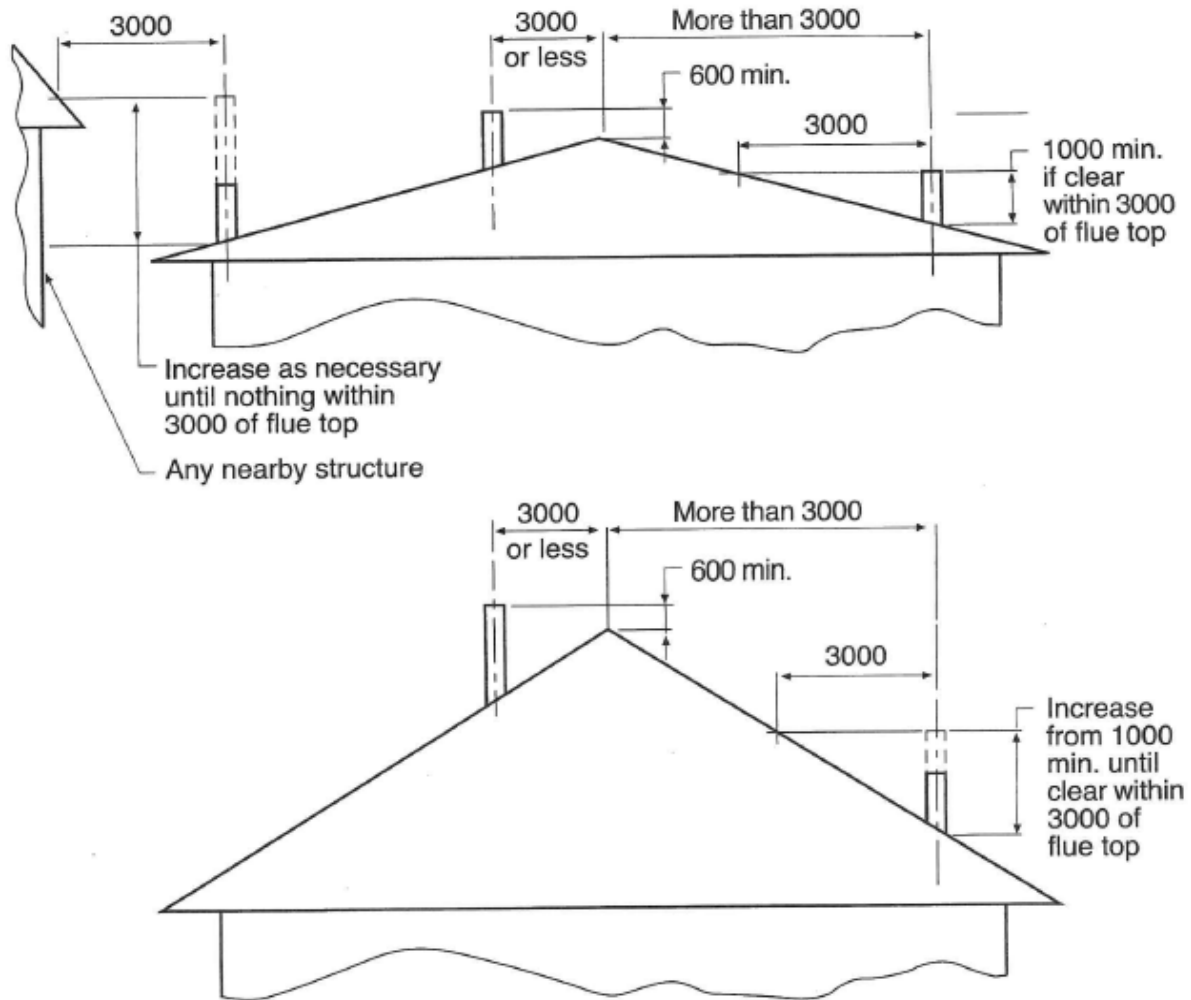

NOTES:

1. The flue shall extend not less than 4.6m above the top of the floor protector.
2. The flue cowl must be at least 600mm above the highest point of the roof if within 3 metres of it, or 1 metre above the roof penetration if more than 3 metres from the ridge.
3. No part of the building, or any adjacent building may be in or above a circular area of a horizontal radius of 3 metres from the flue exit.

OUTSIDE AIR KIT EXPLODED VIEW VIKING Rural Dry



**Firenzo
Woodfires**
The heart of a warm home

OUTSIDE AIR KIT

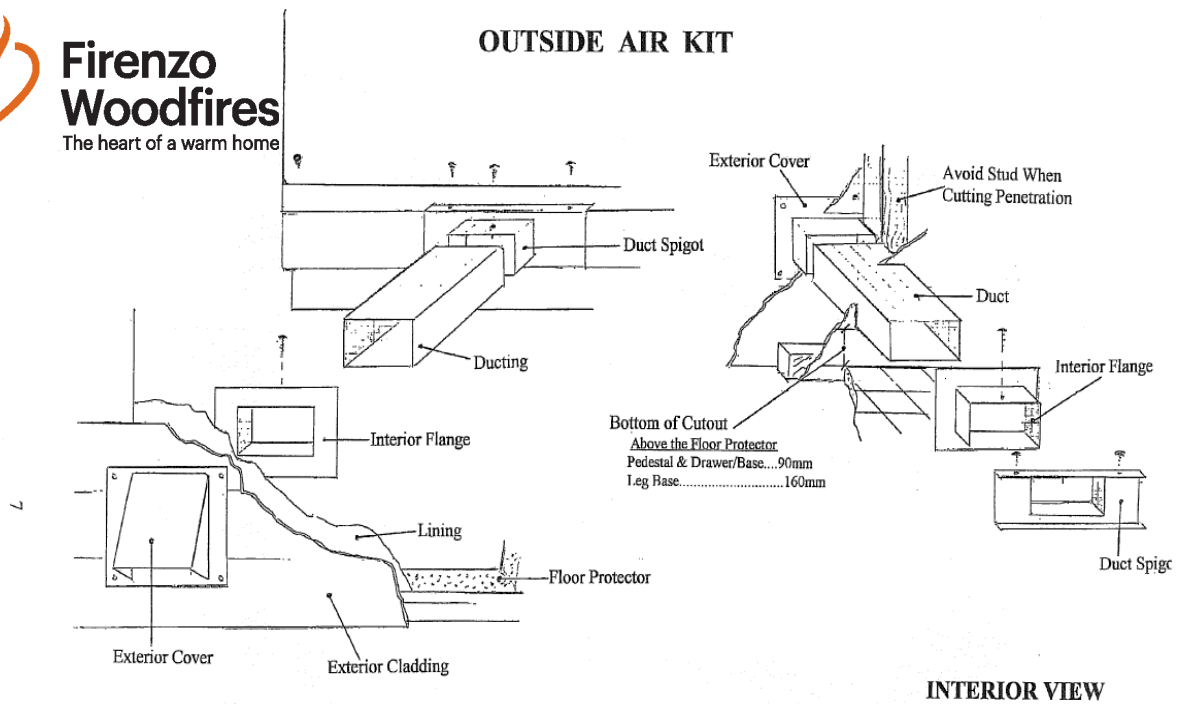

EXTERIOR VIEW

Manufactured by
Hewitsons Limited
Hawkes Bay, New Zealand

**The part of the Duct that goes through the wall is 90mm wide and 70mm deep.
All work carried out must meet the New Zealand Building Code or Codes.**

OUTSIDE AIR KIT INSTALLATION INSTRUCTIONS VIKING Rural Dry

To gain optimum performance from your Fire we recommend you fit an outside Air Kit. All fires need heat, oxygen and fuel to work efficiently. With all new homes being so well insulated, double glazed and having extraction fan units, the fire can be starved of oxygen resulting in making the fire hard to start and smoky. If the fire is pulling oxygen from the room it has already heated, it is pulling in warm air that you have already paid to heat.

1. Establish position of Fire before fixing.
2. Cut holes in both lining and exterior cladding of approx. 100mm wide and 75mm high to accommodate duct (see drawings).
3. If a wall stud is located at centre of Fire position. The wall penetration should be moved to one side. Allowance is made on the Fire to move ducting laterally by placing offset duct spigot in appropriate position.
4. Remove rear heat shield and fit duct spigot by drilling and securing to body ensuring that it lines up with the wall penetration.
5. Replace heat shield and secure the Fire in place.
6. From outside feed the duct through the wall, slip the interior flange over the duct and push into the duct spigot on Fire. (Mark and trim the duct if necessary, this should terminate approximately 5-10mm short of the external wall face).
7. Place the external cover over the duct and fix with the 4 screws provided.
8. Slide interior flange against lining and secure to duct.
9. Outside Air Kit must be fitted to relevant Building Code or Codes.

7. OPERATING INSTRUCTIONS

PLEASE READ CAREFULLY BEFORE PROCEEDING ANY FURTHER.

PLEASE KEEP THIS BOOK IN A SAFE PLACE.

FIRST BURN:

On the INITIAL LIGHTING ONLY, the high temperature paint used on your Fire will give off smoke and odour for several hours. As this is a temporary condition, open doors, windows, etc. to give adequate ventilation.

1. Prepare fire by placing crumpled paper in middle of firebox. Do not use a grate, or elevate fire. Build fire directly on floor of firebox.

2. Pull **air control knob out fully for high** (this is the small knob to the right of the door).

AIR CONTROL OUT = HIGH

AIR CONTROL KNOB IN = LOW

3. Arrange dry kindling in “tepee” style with larger pieces standing up on each side. Ignite paper leaving door ajar until kindling is alight.

4. When vigorous flaming of the kindling subsides and embers begin to appear, reload with larger wood, placing them in a front to back configuration.

5. Open door carefully and place small pieces, then larger logs on top.

6. Close door tight and leave Air Control on ‘HIGH’ for some 30 minutes. The value in establishing this technique is that you are providing an excellent base for burning your wood effectively and without smoke therefore pollution free.

7. When a good fire is established move air control to middle position. **DO NOT IMMEDIATELY SHUT THE FIRE TO ‘LOW’**. Remember to close the air control gradually to your desired level of heat output. It is better to take 3-4 adjustments to get to the low setting (extended burn).

RELOADING:

WARNING: IT IS NECESSARY TO MOVE THE AIR CONTROL TO ‘HIGH’ BEFORE OPENING THE DOOR.

Never open the door when a vigorous fire is in progress. Wait until the flames have subsided and the wood has broken up into glowing embers. Reload with dry logs in a **front to back formation** (i.e. parallel to the sides).

Leave the air control on the ‘High’ position for 10 to 15 minutes or until the flames begin to subside. This shows that the initial highly volatile wood gases have been driven off and the Fire will be able to maintain an even burning rate.

Normally a light load of fuel will stabilize quickly but a full load will take longer. Once the burning rate has stabilized move the Air Control to a medium position.

RE-LOADING AFTER AN EXTENDED BURN TIME

At the end of an extended burn, re-establish the fire by adding a few small split logs, adjust the Air Control to 'High' and allow the firebox temperature to build up before adding the balance

The addition of large quantities of cold fuel to a low fire will reduce the firebox temperature dramatically and this may result in 'losing' the fire.

Proceed with fire as before.

Do NOT operate the Fire with the door constantly open, this overrides the Air Control and greatly lowers optimum heat output, efficiency and increases emissions.

FLAMMABLE LIQUIDS:

WARNING: DO NOT USE FLAMMABLE LIQUIDS E.G. GASOLINE-TYPE FUEL, KEROSENE, CHARCOAL LIGHTER FUEL, ETC OR AEROSOLS TO START OR REKINDLE THE FIRE.

STORAGE OF FUEL:

WARNING: DO NOT STORE FUEL WITHIN FIRE INSTALLATION CLEARANCES.

It takes from **12-24 months** to dry wood properly. Drying wood gives off a lot of water. To prevent rot and speed drying, you should provide good air circulation around the woodpile. Use a few boards to keep your wood level and off the ground. Cover wood so it is waterproof but make sure you let the sides breathe. Open-sided sheds offer an ideal way to store wood and keep it dry.

CLEANING THE ASHES FROM THE FIRE:

Disposal of Ashes:

Ashes should be placed in a metal container with a tight fitting lid. The closed container of ashes should be placed on a non-combustible floor on the ground, well away from all combustible materials, pending final disposal, If the ashes are disposed of by burial in soil or otherwise locally dispersed, they should be retained in the closed container until all cinders have thoroughly cooled.

A LAYER OF ASH AT LEAST 25MM DEEP SHOULD ALWAYS BE LEFT IN THE BOTTOM OF THE FIRE TO PROTECT THE BOTTOM OF THE FIREBOX AND IT WILL ALSO ACT AS 'INSULATION' FOR THE FIRE.

WARNING: DO NOT REMOVE EXCESS ASH FROM THE FIREBOX BY VACUUM UNLESS THE FIRE HAS BEEN OUT FOR 5 OR MORE DAYS—EMBERS WILL SMOULDER FOR SEVERAL DAYS AND WILL IGNITE VACUUM CLEANER BAGS.

8. DOOR GLASS

The Viking is equipped with a self-cleaning glass air wash system. A discolouration can form after a long 'low' burn, but 30 minutes of 'high' burn should clear it from the glass.

Clean glass with wet newspaper dipped in ash from the firebox, then wipe glass.

Do NOT clean the glass while hot.

CAUTION: THIS FIRE SHOULD NOT BE OPERATED WITH A CRACKED GLASS.

If a replacement of glass is required:

GLASS MUST BE REPLACED WITH FIRENZO CERAMIC GLASS

Insulating material for the glass should be replaced at this time also. NEVER place glass directly against the door. Without the insulation seal tape in place, the glass is likely to shatter. Your Firenzo dealer will be able to supply any spare parts.

9. POWDER COATED TOP

We do **NOT** recommend using the top of the fire for cooking on as the paint may become discoloured and Firenzo accept no responsibility should this occur.

Note: The top plate surface is a powder coated finish and is **NOT** designed as a direct cooking medium. The use of a trivet is recommended to prevent scratching the powder coated surface. Moisture or spillages must be wiped clean to prevent deterioration of the powder coated finish. If you want to cook, lift decorative top plate off and cook on the cast tops underneath.

10. MAINTENANCE

SECONDARY CHAMBER:

The baffles (horizontal bricks in the ceiling of firebox) are critical to the Fires performance. They should be checked annually during flue cleaning and replaced if signs of deterioration are evident.

1. Lift the steel top plate and then the front cast top plate from the unit and remove.
2. Remove any soot and creosote build-up from the secondary chamber.
3. Check baffles.
4. Replace cast top and steel top plate.

FLUE:

Creosote is caused by burning wet fuel, leaving particles and condensation to build up on the inside of any closed solid fuel heater. Creosote and soot left to build up can cause decreased heat performance and flue fires. Your heating retailer or local reputable chimney sweep will be able to assist with flue cleaning. Before commencing the flue clean it is best to remove the baffles to avoid breakages. To do this, first lift off steel top plate and the front cast top (take care it will be heavy and dirty underneath), take out the remaining baffles.

DOOR HANDLE AND HINGES:

Light Lubrication is recommended once a year before the first autumn burn. Use a little GRAPHITE grease, available from any garage or engineering outlet. Take care not to over wind the nut on handle as this will strip the spindle thread.

SECONDARY AIR TUBE:

The Secondary Air Tubes are a consumable item and are serviceable. Please check on a regular basis for wear and tear.

FIRE BRICKS:

The internal fire bricks on the sides and base of the firebox can crack in extreme heat. However they are safe to leave as is until they start to crumble in which case they should be replaced.

FIRE ROPE:

As part of the general maintenance the door rope and glass tape should be checked and replaced regularly. Failure to do this may overfire your Fire.

WELDS:

The 5mm exposed steel sill and deflector in the fire box is welded on each side but primarily to the firebox underneath. With expansion and contraction the side welds develop hairline cracks. Do not be alarmed the main weld is sound and the Fire will not be effected in any way. Any hairline cracks are not a structural problem.

INTERNAL DISCOLOURATION:

A brown (rust like) colouration will develop on the exposed inside of the fire box. This is expected over time and does not affect the performance of the fire.

11. SAFETY

All surfaces on the **Viking** will get hot and cause burning if touched by bare hands. We recommend using a fireguard.

The heat from the fire will effectively dry laundry and other wet articles; however such materials should be kept well clear of the Fire to prevent accidental fires.

The flue should be cleaned regularly (at least annually prior to the winter) to avoid flue fires. In such an event, close the air control. Do NOT open door. Remove combustible items from near the Fire and Flue.

12. WARRANTIES

Terms applicable to Firenzo Wood fires' warranties (current as at 29th May 2015)

1. Hewitsons Limited (company number 569753) with a specified address of 98 Niven Street, Onekawa, Napier (Firenzo) and trading as Firenzo Wood fires gives:
 - a ten (10) year warranty but **ONLY** for the steel firebox, fascias and cast iron components of all Firenzo wood fires.
 - a one (1) year warranty for all other parts and finishes of a Firenzo wood fire including its refractory linings, glass, air supply components, wetback, seals, tapes and extrusions.
2. The warranty periods commence on the original date of sale of the relevant Firenzo wood fire to a consumer (please see paragraphs 5 and 8).
3. The warranties are given in respect of any defects in the specified Firenzo component parts and materials and Firenzo workmanship that render the component parts and materials unfit for normal domestic use.
4. The warranties have qualifying limitations, restrictions and conditions attached to them. Please see paragraphs 5, 6, 7, 8, 10 and 14.
5. Firenzo gives the warranties only to New Zealand consumers as defined in the Consumer Guarantees Act 1993. Please also see paragraph 17. The warranties are additional to the rights available to consumers against the manufacturer under the Consumer Guarantees Act 1993. To the fullest extent permitted at law, no other warranties or guarantees, express or implied, are assumed or given by Firenzo to any person with respect to the quality, merchantability, description or fitness for purpose or use of Firenzo wood fires or their component parts and materials.
6. Firenzo is not liable for, and to the maximum extent permitted by law excludes any liability for, any consequential loss or damage arising out of the installation, ownership or use of a Firenzo wood fire. To the extent such liability cannot lawfully be excluded, Firenzo's liability is limited to the purchase price paid for the Firenzo wood fire.
7. The warranties do not apply to:
 - normal wear and tear:
 - performance issues or limitations affecting a Firenzo wood fire arising out of
 - prevailing site conditions such as downdraughts or insufficient draw or from,
 - incorrect servicing adjustments or incorrect flue components or installation.
8. The warranties are valid only if the original purchasing consumer completes and returns a copy of the prescribed Warranty Registration Card to Firenzo at the specified address, dated the sale date, and specifying the residential address where the Firenzo wood fire is installed. The original purchasing consumer should keep their part of the Warranty Registration Card for validating warranty claims.
9. The warranties may be assigned to other consumers (as defined in the Consumer Guarantees Act 1993) on any sale of the residential property where a Firenzo wood fire has been installed.

10. For information (including claim procedures) concerning potential claims, potential warranty claimants should contact:

in the first instance, the retailer/dealer from whom the Firenzo wood fire was originally purchased; or

(if the retailer/dealer is not contactable or does not address the claim to the claimant's satisfaction) Firenzo at the specified address, including as appropriate to arrange an inspection of the Firenzo wood fire.

11. After complying with paragraph 10, for valid claims, a warranty claimant must submit a completed warranty claim form (please see Firenzo's website, or contact Firenzo, for this form) or other form acceptable to Firenzo providing details of the consumer's warranty from the Warranty Registration Card (including its date of issue) and specifying the defect:

to the retailer/dealer from whom the Firenzo wood fire was originally purchased; or
to Firenzo at the specified address.

12. The warranty claimant is responsible for paying any service call fees, transport charges and for any damages and loss incurred in transit to the Firenzo wood fire or its component parts and materials, to and from Firenzo or its designated accredited agent. Where Firenzo honours a warranty, as described in paragraph 13, it will reimburse the warranty claimant any transportation costs they have incurred.

13. Firenzo or its designated accredited agent (please see paragraph 16) will replace any component parts and materials covered by the warranties or the entire Firenzo wood fire, at its discretion, where Firenzo is reasonably satisfied a defect is solely due to faulty Firenzo workmanship or materials.

14. Firenzo may decline (in whole or part) to honour a warranty claim:

- until any amounts due but unpaid by a consumer in respect of the Firenzo wood fire or its servicing are paid.
- until Firenzo is provided with the applicable compliance and installation permits (please see below);
- if it appears to Firenzo that the Firenzo wood fire has:
 - not been installed correctly at the specified residential address, or not been operated and maintained strictly in accordance with the manufacturer's instructions, AS/NZS 2918:2001 and any relevant building code or consent or these warranty terms.
 - not been inspected and confirmed after installation as a compliant installation (with the requisite specifications and permits).
 - not been regularly maintained and at least annually serviced.
 - been operated with faulty, worn or missing seals.
 - been subject to misuse, neglect, or accident in transit, storage or use.
 - been damaged by water ingress in any way, including any surface rust which has occurred in transit or storage. However this exclusion will not apply to any damage to the Firenzo wood fire which is determined to have been caused by the wetback.
 - been over fired or has used any fuel other than clean dry firewood (having 25% or less moisture content), including any chemically treated timbers or driftwood.
- if it appears to Firenzo that the defect is attributable to a failure to replace consumable parts or components or materials within a timely manner to maintain their durability.

15. Firenzo reserves the rights to alter or supplement the warranties, but no alteration will reduce a consumer's rights under the warranties that applied at the date of original acquisition of the applicable Firenzo wood fire. In the event of any inconsistency between the warranties and any other written Firenzo material, including a manual, the warranties shall prevail to the extent of the inconsistency.

16. No person other than a designated accredited agent can bind Firenzo with respect to Firenzo's obligations under the warranties, and then only in accordance with the agent's actual authorities. A person is a designated accredited agent where they are identified and certified in writing by Firenzo to be such with their authorities specified in the certificate. Consumers must take reasonable steps to satisfy themselves that they are dealing with designated accredited agents.

17. The warranties do not apply to export sales of Firenzo wood fires. Separate terms apply to those sales.

For any questions about the warranties or this document please contact Firenzo at its specified address, on telephone 06 8438260, by email at firenzo@firenzo.co.nz, or via the Firenzo website www.firenzo.co.nz.

18. This document is intended to form part of (and may be expressly referenced in) the terms of sale and purchase by every original New Zealand consumer of a Firenzo wood fire. Without limiting that intent:

- by the act of completing and returning a copy of the prescribed Warranty Registration Card to Firenzo at the specified address (or other address for the time being), a consumer is also deemed to acknowledge that he or she is bound by the warranty terms;
- a copy of this document is to be executed by Firenzo as a deed poll in favour and for the benefit of the New Zealand consumers described in it and to be kept for inspection purposes with Firenzo's corporate records at its specified address.

Model: -

Viking AG Dry

Serial No: _____

Date of Purchase: _____

Purchased from: _____

Please complete for your reference

NB: The Warranties Registration Card is located in the information pack that accompanied your new wood fire, it **MUST** be filled out and returned to Firenzo.



Firenzo Woodfires

The heart of a warm home

WOODFIRES

by

FIRENZO

Manufacturers of:

[Free standing](#)

Bronte

Contessa

Encore

Lady Kitchener

Napier

Viking

Vision

[Insert](#)

Aqualux

Athena Bay & Flush

Forte Bay & Flush

Kompact Athena

Kompact Deco

Kompact Diva

Kompact Forte

Kompact Plaza

Kompact Serenity

Topaz

98 Niven Street

PO Box 3231

HB Mail Centre

Napier 4142

Phone: 06 843 8260

Website: www.firenzo.co.nz

email: firenzo@firenzo.co.nz