

0
1
2
3
4
5
6

Installation and Operating Instructions

Model:
PPOV-9S-48



Fix your serial number sticker here for easy reference.
You will need this serial number should your appliance require servicing.

As part of Parmco Appliances commitment to improving and updating product ranges, we reserve the right to alter, change and update technical specifications and appearance attributes of all Parmco Appliances products. E&OE.

727626072023

Inspiring kitchens, entertaining homes

Parmco Appliances extended 7 year warranty



The Warranty:

- This appliance is intended for domestic use in the owners' home. Use of the appliance for commercial purposes will limit the warranty period (please see Parmco website for commercial details).
- Subject to the terms and conditions contained within this warranty, if the product is not of Acceptable Quality (as defined in the Consumer Guarantees Act) within 7 years of the date of original purchase, then Parmco Sales undertakes to repair or, at its sole discretion, replace the product.
- The warranty does not cover the costs of transport, mileage or travelling time if the product is located beyond 30km of a recognised Service Agent.
- This warranty is offered as an extra benefit, and does not affect other legal rights, which can not be modified or excluded by agreement.
- This warranty only applies to goods supplied and installed in the North and South Islands of New Zealand.
- The provisions of this warranty are in addition to the rights and remedies available to consumers under the Consumer Guarantees Act 1993.

Product _____ Date of purchase _____
Serial Number _____
Dealer / Retailers Name _____

Please retain this Warranty card together with receipt or other proof of purchase date when seeking service during the warranty period

Please contact Parmco at 09 573 5678 if your appliance needs servicing under warranty. Please have your model number and proof of purchase ready. Warranty repairs must be authorized by Parmco.

The Warranty is not valid:

- If the product is not installed and operated in accordance with the operating instructions.
- If the product is not installed to comply with the electrical, gas, plumbing and other Regulations and Codes of Practice in New Zealand.
- If the product is operated on voltages or frequencies outside the normal range for domestic appliances in New Zealand.
- If the product is not used in normal domestic use, or if it is used in a business as defined in the Consumer Guarantees Act.
- If any serial number has been removed or defaced.
- If proof of date of purchase is not supplied, except at the sole discretion of Parmco Sales. Proof of purchase can be for the product itself, or if installed with a kitchen or house then proof of purchase can be from a Parmco reseller of products supplied by Parmco.
- If the products are purchased in a second hand condition from other parties (including but not limited to TradeMe, Sella, etc.)

Liability under this warranty will not be accepted for:

- Wear and tear caused by normal domestic use of the product.
- Damage in transport.
- Damage caused to the product by neglect, abuse, negligence, wilful act or misuse.
- Any costs associated with the repair, replacement, removal or reinstallation of products installed in a damaged condition.
- Any defect caused by accident, misuse, neglect, tampering with or unauthorised modifications of the appliance or any attempt at internal adjustment or repair by any person other than an Authorised Service Agent.
- Service calls that relate principally to the following:
 - Instruction on how to use the product.
 - Repair or replacement of house fuses, electrical wiring, gas fitting or plumbing.
 - Normal or scheduled maintenance including blocked filters or ducting.
 - Consumable items such as light bulbs.
 - Any damage to hobs caused by spills when cooking.
 - Any breakage or damage of glass items.
 - Any damage caused by non recommended product used for cleaning, maintaining, lubricating or similar.
 - Any aspect relating to the installation of the product, or damage caused during installation including blocked access for repair.
 - Any third party (including reseller) or consequential loss or damage (direct or indirect) however arising.



Dear Valued Customer,

Thank you and congratulations on purchasing your new Parmco appliance.

All Parmco products are made to the highest quality and design standards. We are sure you will enjoy your new appliance.

As a note, please read through these instructions carefully. These will assist you in gaining a complete understanding of the functions and features offered by your appliance. Please take special note of all detailed technical information and installation instructions. It is essential that you follow these instructions to ensure the safety and reliability of this appliance.

Furthermore, not using appropriate personnel to install this appliance may affect any future warranty claims lodged, so please check with Parmco Appliances before any installation is carried out.

We hope you enjoy your new appliance. If you would like to find out more about this product or any other products in Parmco's extensive range, visit us online at www.parmco.co.nz.

Regards,
The Parmco Team

PARMCO

Inspiring kitchens, entertaining homes

INDEX

	PAGE
Important Safety Information	4
Use and Care	5
Product Description	6
Operating Instructions	7
Oven Functions	11
Practical advice	13
Cooking guide	14
Maintenance	15
Installation Instructions	18
Technical data	20



IMPORTANT NOTE

It is the law in New Zealand that this appliance must be installed by authorised persons. The installation must comply with all the appropriate New Zealand Standards and Regulatory Requirements with particular reference to the New Zealand Electrical Standards.

Any attempt to install this or any other Parmco product without an authorised person could result in damage to the product and a possible health hazard. Not having an authorised person install this appliance may result in all associated warranties from Parmco Appliances being null and void.

IMPORTANT SAFETY INFORMATION

We recommend that for best performance and to extend the life of your appliance you read the instructions in this owner's manual thoroughly before using your new appliance. It will provide you with all the information you need to ensure its safe installation, proper use and maintenance. Retain this owner's manual for future reference.

To maintain the efficiency and safety of this appliance we recommend the following:

Before using this appliance

Read the instructions thoroughly.

- Remove all plastic protective films on the appliance before using the appliance.
- Remove the plastic film on the oven glass door (when provided).
- To condition the oven for its first use it is necessary to allow oils and residues used to protect the appliances during manufacture to burn off. Heat the empty oven at maximum temperature for 45 minutes on Fan Bake function. This allows unpleasant smells and smoke from protective oils used during manufacture and from new thermal insulation to burn off.
- Allow the unit to cool off and wash the oven out with soapy water and then rinse.
- The oven only operates when the time has been set
- NEVER place anything on the bottom of the oven when it is in operation because this will damage the enamel.

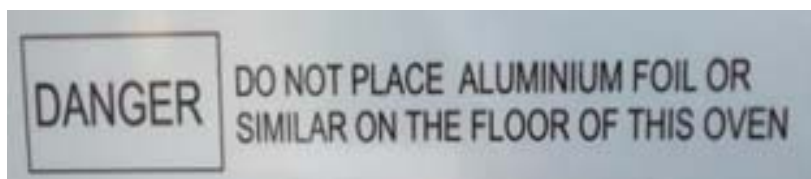

For your safety

- This appliance is designed for non-commercial, household use only and must not be altered in any way.
- This appliance can only be used safely when it is correctly connected to an efficient earthing system in compliance with New Zealand Electrical Standards requirements.
- Before maintenance or cleaning, always ensure that the appliance is disconnected from the mains.
- Always use oven gloves to remove and replace cookware in the oven.
- Packaging items such as plastic bags, polystyrene, nails etc that this appliance is delivered in are potentially dangerous, and therefore appropriate measures must be taken to prevent children from coming into contact with them.
- This appliance must only be used by adults. Make sure that children do not touch the controls or play with the appliance. Young children should be supervised to ensure they do not play with the appliance.
- Do not allow children to sit on or play with the oven door.
- Do not use the drop down door as a stool to reach overhead cabinets.
- This appliance is not intended for use by persons (including children) with reduced physical, sensory, or mental capabilities, or lack of experience and knowledge, unless they have been given supervision or instruction concerning the use of this appliance by a person responsible for their safety.

- The appliance becomes hot during use. Care should be taken to avoid touching heating elements inside the oven.
- Keep the appliance thoroughly cleaned. Food residues may cause fire risks.
- DO NOT use a steam cleaner to clean this appliance.
- **NEVER place aluminium sheets, tins, trays or utensils directly on the bottom of the oven as doing so may damage the enamel and elements.**
- WARNING: Accessible parts may become hot during use. To avoid burns, young children should be kept away.
- Do not use harsh abrasive cleaners or sharp metal scrapers to clean the oven door glass since they can scratch the surface and cause the glass to shatter.
- After using the appliance please ensure that all controls are in the “OFF” position.
- Avoid touching the oven with wet body parts.
- Avoid improper or dangerous use of this appliance.
- Do not obstruct the ventilation or heat dissipation slots.
- Do not allow power cables of other appliances to come into contact with hot parts of this appliance.
- This appliance is intended for indoor use only. Avoid exposing the appliance to atmospheric elements such as direct sunlight and rain.
- DO NOT USE OR STORE FLAMMABLE MATERIALS IN THE APPLIANCE OR NEAR THIS APPLIANCE.
- For any enquiries please contact Parmco Appliances (09) 573 5678.

USE AND CARE

How to use your oven

We recommend that you read the instructions in this owner's manual carefully before use. It will provide you with all the instructions you require to ensure safe installation, use and maintenance. Always keep this owner's manual close to hand since you may need to refer to it in the future. Place the spare serial number sticker on the front of this manual for future reference as you will need the serial number should this appliance need servicing.

It is important to remember that this oven may perform differently to the way your previous appliance worked. To obtain the best cooking results please experiment with the temperature, rack height and cooking times. As a guide to help you with this process please refer to the “Cooking Mode Table”.

This multi-function oven combines the advantages of traditional convection ovens with those of the more modern fan assisted models in a single appliance. It is an extremely versatile.

Steam and Condensation

Often owners of new ovens will see a higher level of steam and condensation than they are used to in their previous appliance. This is normal and contributes to keeping the food moist during cooking. The amount of steam and condensation will depend on the type of food (fresh, defrosted, frozen) being cooked. The style of cooking (water baths) will also contribute to the amount of steam and condensation generated. Climatic conditions also contribute to the generation of condensation.

When food is heated it produces steam in the same way a boiling kettle does. When steam comes into contact with the oven door glass it will condensate and produce droplets. To reduce condensation, ensure that the oven is well heated before placing food in the oven cavity. Oven pre-heating is necessary before any cooking!

It is normal for steam to escape the oven when opening the door. To reduce the build-up of condensation, pre-heat the oven for longer periods and occasionally open the door and carefully wipe away the condensation. Adjusting your cooking practices will also ensure a minimum build up of condensation.

PRODUCT DESCRIPTION

- The Electronic Oven Control Panel

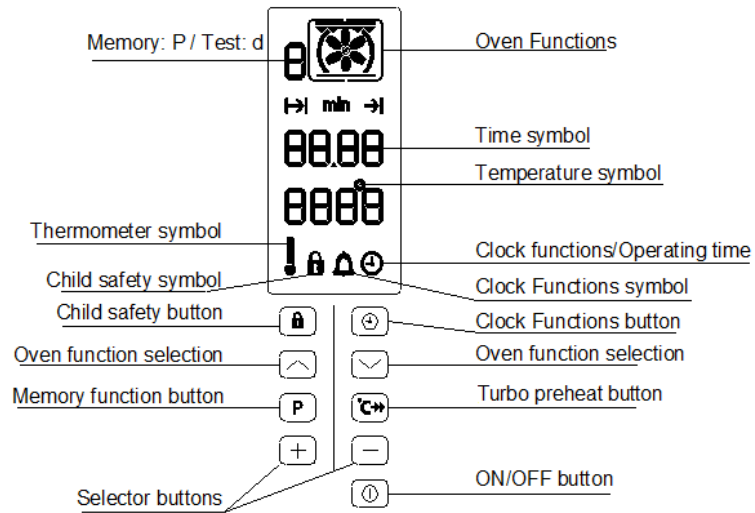

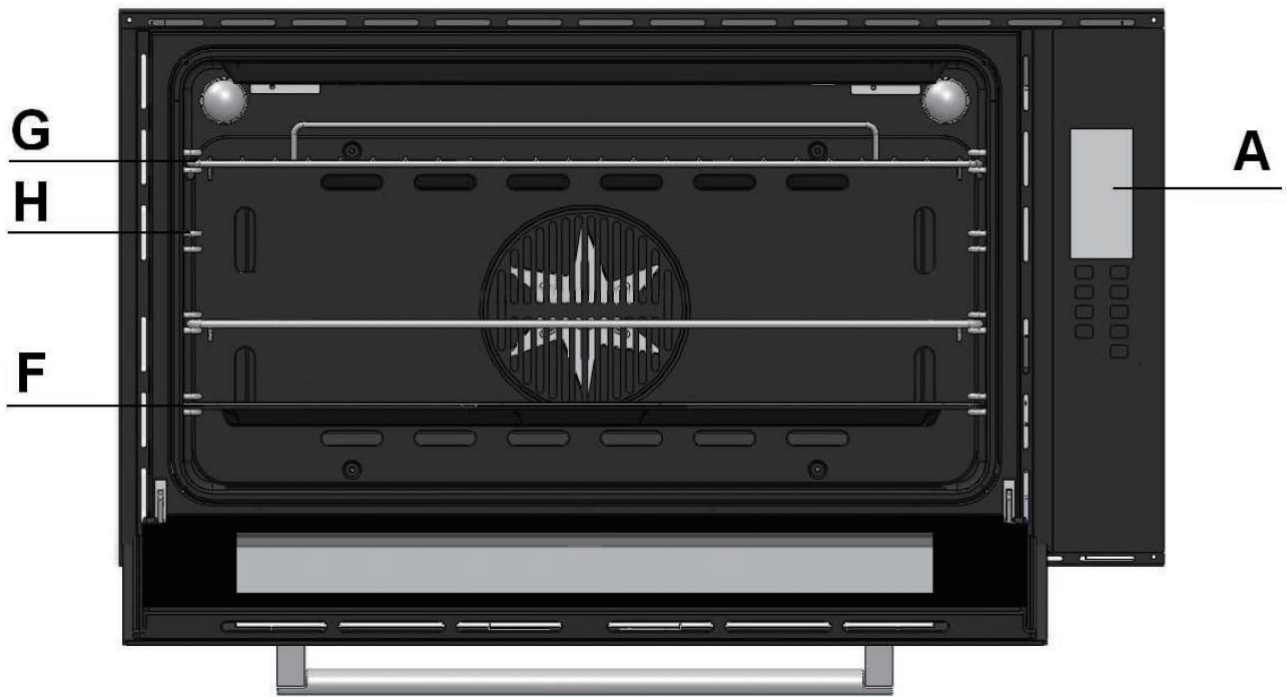

- A** Control Panel
- G** Oven Rack
- H** Side Rails
- F** Roast Dish / Grilling Dish



OPERATING INSTRUCTIONS

GENERAL INSTRUCTIONS

1. The oven only operates when the time has been set.
2. Always switch the appliance on first by pressing the On/Off  button.
3. When the desired function is set, the oven will heat up. A suggested temperature will appear on the display.
4. The oven light is permanently on when in operation. The oven light will automatically switch off 10 minutes after operation has ceased.
5. Switch the appliance off using the On/Off  button.
6. Do not open door whilst oven is pre-heating. By opening the door it will not allow the oven to reach full temperature.

IMPORTANT INFORMATION



Please be aware this oven has a unique pre heating function to reduce the time it takes to reach temperature therefore saving energy. When a heating option has been selected the oven will utilize the rear fan, rear element and lower element to preheat the oven to the set temperature. Once the oven has reached the set temperature the rear fan, rear element and lower element will switch off and continue operating with the heating element associated with the desired function.

BEFORE FIRST TIME USE



This oven will not operate until the clock time has been set.

Setting the Clock



The oven only operates when the time has been set. When the appliance is connected to the electrical supply or when there has been a power cut, the symbol for Time flashes automatically. This is only a 24 hour clock.

1. To set or change the time, the oven must be off
2. To change time, press the Clock function button and hold until the symbol  for time flashes.
3. Using the  or  button, set the current time. After about 5 seconds, the clock stops flashing and displays the set time. The appliance is now ready for use.



Selecting the oven function

1. Switch on the oven, press and hold the On/Off  button.
 2. Press the  or  button until the desired oven function appears.
- A suggested temperature appears on the temperature display.
 - If the suggested temperature is not changed within 5 seconds, the oven begins to heat up.



Changing the oven function

1. To change the oven function, press the  or  button repeatedly until the desired oven function is displayed.
- When a function mode is changed the suggested temperature of 180°C must be adjusted if required.

Changing the oven temperature



1. Press the  or  button, to raise or lower the temperature. The setting changes in increments/decrements of 5°C
2. An alarm will be heard and the temperature on the display screen will begin to flash. While it is flashing you can change the temperature using the + or – buttons.
3. Once the desired temperature is selected, the display will flash 5 times and then solidify, indicating temperature has been set.

Thermometer symbol

- The slowly rising bars on the thermometer symbol  indicates how hot the oven is as it heats up. Bars become solid as the oven reaches certain temperatures during the pre heating process. Once the oven has reached the selected temperature an alarm will be heard once and the last bar will flash for approximately 1 minute and then become solid.
- Three rapidly rising bars on the thermometer symbol  show that Turbo pre heat has been selected. Once selected temperature is reached an alarm is heard twice and all 3 rising bars become solid.

Speed pre-heat

After an oven function is selected, with the use of the additional Speed pre heat function, the empty oven can be pre-heated in a faster short time. For example 190 will take 10 mins.



1. Set the desired cooking function. If necessary, change the suggested temperature.
 2. Press the Turbo preheat  button. The symbol  lights up.
- The bars are flashing rapidly after another show that Turbo pre heat cook function is operating.
 - When the temperature set is reached, the bars of the heat indicator all light up and the alarm sounds.
 - The oven will now continue heating according to the pre-set oven function and temperature. You can now place food in the oven.





Important: Do not put the food to be cooked into the oven, until Speed pre-heat is completed and the oven is operating using the desired function.

CLOCK FUNCTIONS

General instructions

After a clock function has been selected, the corresponding symbol flashes for approx. 5 seconds. During this time, the desired times can be set or modified using the  or  button.

Once the time has been set, the minute minder will begin to count down, or the time set for Cook Time  or End Time  begins to count down. Once the set time has elapsed the oven will turn off.

Please note the End Time can only be used in conjunction with Cook Time.







- Minute Minder - allows you to use the oven as a timer (this function can only be used when the oven is off)
- Cook Time – is the time required to cook the food (how long the oven is in use)
- End Time – is the time at which the oven needs to turn off.

Time







To set, change or check the time (See “Before first time use” section)

Minute Minder

Minute Minder - allows you to use the oven as a timer (this function can only be used when the oven is off).



- Press the Clock Function  button repeatedly until the symbol for Minute minder  flashes.
- Set the desired Countdown time using the  or  button (max.59 minutes).
- The symbol for Minute minder  lights up.
- When the time set has elapsed, an audible alarm sounds for 1 minute. “0.00”lights up and the symbol for Minute minder  flashes. To turn off the alarm press any button.







Cook time

- Select oven function by pressing  or  button, then select desired temperature using the  or  buttons
- Press the Clock Function button once until the symbol for Cook time flashes.
- Use the  or  button to set the desired cooking time. The oven switches itself on and the symbol for Cook time lights up
- By pressing the Clock Function button once, the current time can be displayed.
- When the time has elapsed, an audible alarm sounds once and then oven switches itself off. “0.00”is displayed and the symbol for Cook time flashes. To turn off the alarm, press any button

Delayed Start function



The timer can be set so that the oven will come on at a pre-determined time and cook for a specified period then turn itself off. The oven will automatically calculate the delayed start time from the finishing time selected. Please note that you will need to take into account the time for preheating when setting this function.

- Please ensure the time is set (See “Before first time use”)
- Select oven function and temperature.
- Using the Cook time function , set the time that the dish needs to cook,
- Using the End time function , set the time at which the dish is to be ready,
- The symbols for Cook time and End time light up.
- The oven switches on automatically at the time set.
- When the set cooking time has elapsed, an alarm sounds and then the oven switches itself off.



Note: Delayed start function can be set for       these functions, and delayed start function cannot be set for other functions.

OTHER FUNCTIONS

Programme Memory function



- The Memory function can be used to save a setting which is frequently used. Only has 1 memory setting.
- Set the oven function, temperature and if necessary the clock function, Cook time  and/or End time
- Press and hold the button  for approx. 2 seconds, two beeps will sound. Your preferred setting is now stored. Repeat steps 1-2 to replace the previously saved setting with a new one.

Starting the Memory function

- Switch the oven on using the button On/Off .
- Using the button  recall the saved setting.

Switching off the display





You can save energy by switching off the display.

- Switch off the appliance using the On/Off  button.
- Press the Clock Function  button first, then the  button and hold at the same time until the display goes out.
- As soon as the appliance is switched on again, the display comes on automatically. When the appliance is next switched off, the display goes out again.
- Repeat first two steps to Turn on the display.



Child safety function

The child safety lock can be activated while the oven is off and also at time during operation. As soon as the child safety lock is engaged, none of the controls can be activated.

Activating the child safety device

- With the oven turned off press and hold the  button until  appears in the display. The oven controls are now locked.
- With oven operating press and hold the  button until the  appears in the display. The oven controls are now locked.



Deactivating the child safety device

- Press and hold the button  until  disappears from the display. The child safety device is now deactivated and the appliance controls can be used.



Audible Tone

If preferred, you can disable the button beeps when making selections through the control panel.





To turn off button beeps





- Switch off the appliance using the On/Off  button.
- Press the  button first and then the  buttons and hold together until an audible alarm sounds (approx. 2 seconds). The button beep is now switched off.

Switching on button beeps

- Press the  button first and then the  button. Hold together until an audible alarm sounds (approx. 2 seconds). The button beep is now switched on.

OVEN FUNCTIONS

Cooking Function	Description	Symbol
Conventional Bake	<p>The top and bottom elements operate together like a 'normal' conventional oven that you have probably used before. Conventional mode is best suited for traditional baking and roasting. You should only use one shelf at a time, otherwise there will be uneven heat distribution. You can balance the amount of heat between the top and bottom of the dish by selecting a different shelf height. If you want more heat at the top of the dish, place the dish on the top or second shelf. For more heat on the bottom of the dish, place the dish on the third or fourth shelf.</p>	
Fan Assisted Bake	<p>The top and bottom heating elements, as well as the fan, will come on ,guaranteeing constant heat distributed uniformly throughout the oven. This mode is especially recommended for cooking prepacked food quickly, such as: frozen or pre-cooked food) as well as for a few "home-made" dishes. The best results when cooking using the "Fast cooking" mode are obtained if you use one cooking level only (the second from the bottom), please see the table entitled "Practical Cooking Advice".</p>	
Fan Forced Bake + Bottom Bake	<p>This function uses the bottom and rear heating elements, as well as the fan. This combination rapidly heats the oven due to the large amount of power used by the appliance. This results in the production of considerable heat coming prevalently from the bottom. This mode is ideal for foods requiring high temperatures to cook, such as pizzas and casseroles. Only use one oven tray or rack at a time.</p>	
Multi-Cooking Mode	<p>The top, rear and bottom heating elements along with the fan will all turn on alternately. This creates constant and uniform heat throughout the oven allowing the food to cook and brown evenly throughout the oven. This function is ideal for multi layer cooking as long as the cooking temperature of the items is relatively the same. This mode is ideal for preheating also.</p>	
Fan Forced Bake	<p>This function uses the rear element and fan which provides a delicate heat that is evenly distributed throughout the oven. This mode is ideal for baking and cooking foods on multiple shelves, especially cakes that need to rise such as cream puffs, biscuits, swiss rolls etc.</p> <p>NOTE: This function relies on the air circulation within the oven cavity to provide even temperature. This means the size and placement of trays can affect the temperature distribution. It is usual to have some temperature variations within the oven cavity and this function is NOT a guarantee of perfectly even temperatures throughout the oven.</p>	

Fan assist Bottom Bake	The bottom element and the fan will operate. This mode is most suitable for pizza and pastries that require heat from the bottom.	
Top Bake	The top heating element operates. This mode can be used to brown food at the end of cooking.	
Grill	The top grill element operates with the door closed. The extremely high and direct temperature of the grill makes it possible to brown the surface of meats and roasts while locking the juices in to keep them tender. The grill is also recommended for dishes that require a high temperature on the surface, such as cheese & tomato on toast, chops, and kebabs. Cook in this mode with the oven door shut.	
Fan Assisted Grill	The top grill element and the fan turn on at the same time. The fan distributes the heat evenly throughout the oven. This allows the food to be cooked and browned evenly. This function is ideal for meat and vegetable kebabs, chops, and sausages etc. Cook in this mode with the oven door shut.	
Defrost	The fan located at the back of the oven circulates room temperature air around the oven. This is recommended for defrosting all types of food, but is particularly effective at defrosting delicate food items. It is possible to accelerate the defrosting process by selecting multi-cooking mode and setting the temperature between 80°C and 100°C.	

- **Cooling Fan**

In order to keep the appliance temperature within a safe operating range the appliance is equipped with an automatic cooling fan. This fan comes on when the appliance becomes hot and will continue to run after the appliance has shut off until the appliance has cooled down. When the fan is on, a normal flow of air can be heard exiting between the oven door and the control panel.

Note: When cooking is completed, the fan stays on until the oven cools down sufficiently.

PRACTICAL ADVICE

The oven offers a wide range of alternatives which allows you to cook any type of food in the best possible way. The following directions are only a guideline that may be varied according to your own personal experience.

Preheating

To reduce condensation, ensure that the oven is well heated before placing food in the oven cavity. Oven pre-heating is necessary before any cooking!

If the oven must be preheated, the “Multi-Cooking” mode and the “Speed pre-heat” mode refer pg.8 can be used to reach the desired temperature quickly. Once the food has been placed in the oven, the most appropriate cooking mode can then be selected.

Do not open door whilst oven is pre-heating. By opening the door it will not allow the oven to reach full temperature.

When using the pre- heat function; the fan will automatically switch on regardless of the oven function selected. This is not an oven fault. Once selected temperature is reached; the fan will turn off and your oven will operate at that desired function. However if the fan forced option has been selected, the fan will continue to operate.

Cooking on More Than One Rack

When cooking food on several racks, use the “Fan Forced Bake” mode keeping the following suggestions in mind:

The oven is fitted with 5 rack settings. The lowest and highest racks receive the hot air directly and therefore food could be burnt on these racks.

As a general rule use the 1st and 4th rack from the bottom, placing the foodstuffs that require greater heat on the 1st rack from the bottom. For example, when cooking roast meats together with other food, place the roast on the 1st rack from the bottom and other food on the 4th rack from the bottom.

Using the Grill

This multi-function oven offers you two different grilling modes.



Use the “Grill” mode, with the door shut, place the food under the centre of the grill (situated on the 3rd or 4th rack from the bottom). Use the shallow roast dish with the grill rack provided. When using this mode, we recommend you set the thermostat to the highest setting. However, this does not mean you cannot use lower temperatures.

“Fan Assisted Grill”, with the door shut, is extremely useful for grilling foods rapidly, as the distribution of heat makes it possible not only to brown the surface, but also to cook the bottom part. Also it can be used for browning foods at the end of the cooking process, such as adding that gratin finish to pasta bakes. When using this mode, place the shallow roasting dish and grill rack on the 3rd or 4th rack from the bottom. When using this mode, we advise you to set the thermostat to 200°C as it is the most efficient way to use the grill. However, this does not mean you cannot use lower temperatures.

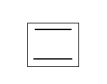

IMPORTANT: Always use the fan assisted grill with the oven door shut.

COOKING GUIDE

Selector knob setting	Food Type	Weight (in KG)	Rack height from bottom	Preheat Time (mins)	Temp Deg C	Cook Time (mins)
Conventional Bake 	Roast Beef	1	3	15	200	70-75
	Roast Pork	1	3	15	200	70-80
	Roast Lamb	1	3	15	200	70-80
	Biscuits		3	15	180	15-20
Fan Assisted Grill 	Chicken	1.5	3	5	MAX	55-60
	Chops		3	10	200	10-15
	Kebabs		3	10	180-190	10-20
Fan Forced Baking 	Sponge cake		3	15	160	25-30
	Cup cakes		3	15	160	15-20
	On 2 racks		2-4			
	Biscuits on 3 racks		1-3-4	15	160	10-15

Please note the above is a guide only and you will need to vary temperatures, times and rack height combinations to achieve the results you want.

CONTACT PARMCO APPLIANCES ON 0800 727 626 FOR ALL REPAIR AND SERVICE ON THIS OVEN.
DO NOT ATTEMPT TO REPAIR OR SERVICE THIS OR ANY OTHER PARMCO PRODUCT WITHOUT PROFESSIONAL ASSISTANCE.

MAINTENANCE

Before cleaning your oven or performing maintenance, disconnect the oven from the power supply.

To extend the life of your oven, it must be cleaned frequently, otherwise further baking and roasting will cause the deposits to bake on even harder and cleaning may become difficult and in extreme cases impossible.

- For best results the oven should be cleaned soon after use when the oven is still warm using warm soapy water
- Wash all roasting trays and wire racks and other accessories frequently
- Do not use scouring pads or cloths, steel wool, knives or other abrasive materials
- Do not use abrasive or corrosive substances as this may damage the enamel
- For tough stains use non caustic cleaners specifically recommended for ovens
- After cleaning, rinse thoroughly and dry the oven.
- **Never use a steam cleaner for cleaning inside of the oven.**

There is a rubber seal surrounding the oven opening which guarantees its optimum performance. Check the condition of the seal on a regular basis. If necessary, clean the seal but avoid using abrasive products. Should the seal become damaged, please contact Parmco Appliances. This may or may not be covered under warranty.

We recommend you avoid using the oven until the seal has been replaced.

Never place anything (including foil and oven trays) on the bottom of the oven when it is in operation as this will result in damage to the enamel.



Make sure the oven is cool before cleaning.

- Do not hand clean the door seal.
- Do not use coarse scouring pads or cleaning sponges.
- To avoid damaging the enamelled oven surfaces, use commercially available oven cleaners.
- To remove stubborn soil, use a special oven cleaner.

Oven door glass

The oven door is equipped with three sheets of glass placed against each other. The inner & middle sheets can be removed for cleaning.

- Do not use harsh abrasive cleaners or sharp metal scrapers to clean the oven door glass since they can scratch the surface, which may result in the shattering of the glass.
- Do not spray oven cleaner on the oven door glass as it may damage it.
- The door becomes light when the glass is removed.
- To remove the glass the oven door hinges must be set to the “locked” position. This will ensure the door does not slam shut when the door glass is removed.



REMOVING THE OVEN DOOR

You can remove the oven door for better access to the oven when cleaning.

- Open the door fully.
- Locate the hinge assembly (1).
- Lift the hinge tab to the open position (2).
- Gently close the door until the hinge assembly engages against the door (3).
- Lift the door up and out at the same time.
- To replace the door, reverse the above procedure making sure that the hinge is correctly located on the small rebate in the hinge arm (4)

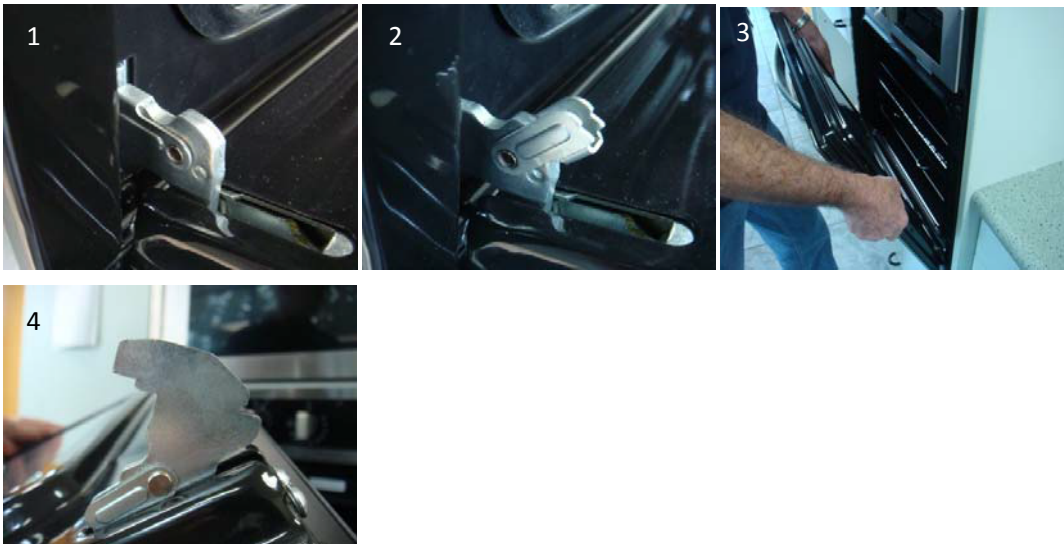

REPLACING THE OVEN LAMP

WARNING: Ensure that the appliance is switched off before replacing the lamp to avoid the possibility of electric shock.

1. Remove the glass cover of the lamp - holder;
2. Remove the lamp and replace with a lamp resistant to high temperatures (300°C) with the following characteristics:
 - a. Voltage: 220-240V
 - b. Wattage: 2X25W
 - c. Type: G9

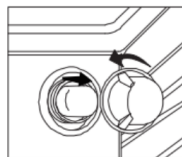

3. Replace the glass cover and reconnect the oven to the mains power supply.

Catalytic Liners

The removable catalytic liners are coated with a dark gray catalytic coating that can become marked with oil and fat during cooking. These deposits will burn off at oven temperatures of 200 °C and higher.

- Higher temperatures will result in faster burning. The oven and accessories should be cleaned after each use. Otherwise further baking and roasting will cause the deposits to bake on even harder and cleaning may become difficult and in extreme cases impossible.

Make sure the oven is cool before cleaning by hand.

- The catalytic liners should be cleaned using a solution of hot water and dish washing liquid applied with a soft nylon brush
- Do not wash in the dishwasher
- Do not use abrasive cleaning agents, hard brushes, scouring pads or cloths, steel wool, knives or other abrasive materials
- Do not use oven spray on catalytic panels as the chemicals used in oven sprays will damage catalytic liners and render them
- If using oven sprays on the interior oven surfaces, the catalytic liners must first be removed from the oven

Before cleaning the catalytic liners using high oven temperatures make sure that all interior oven surfaces have been cleaned as described above. Otherwise, the high temperatures can bake deposits onto the interior oven surfaces and make them impossible to remove.

- Remove all accessories from the oven.
- Set the oven to conventional bake function.
- Set the heat to 250 °C.
- Run the oven for approximately 1 hour. The length of time will depend on the degree of soiling.
- It is a good idea to set the finish time for the process using the end time setting, in case you forget to switch the oven off.
- Any remaining soil will gradually disappear with each subsequent use of the oven at high temperatures. The stains on the catalytic liners caused by grease, fats and oils from cooking are completely normal and will not be able to be completely removed.
- Catalytic liners are a consumable item and can be replaced with new catalytic liners.

INSTALLATION INSTRUCTIONS

IMPORTANT NOTE

It is the law in New Zealand that this appliance must be installed by authorised persons. The installation must comply with all the appropriate New Zealand Standards and Regulatory Requirements with particular reference to the New Zealand Electrical Standards.

Any attempt to install this or any other Parmco product without an authorised person could result in damage to the product and a possible health hazard. Not having an authorised person install this appliance may result in all associated warranties from Parmco Appliances being null and void.



The power supply to the appliance must be turned off before installation.

The dimensions and placement of the ventilation cut outs are critical to the correct functioning of this appliance. Cut out requirements must not be varied.

Installation of Built-in Ovens

- To ensure adequate ventilation, the bottom shelf of the cabinet must have a 50mm cutout for the entire width of the shelf.
- The oven must have a 50mm clearance between the oven and the rear cabinet panel.

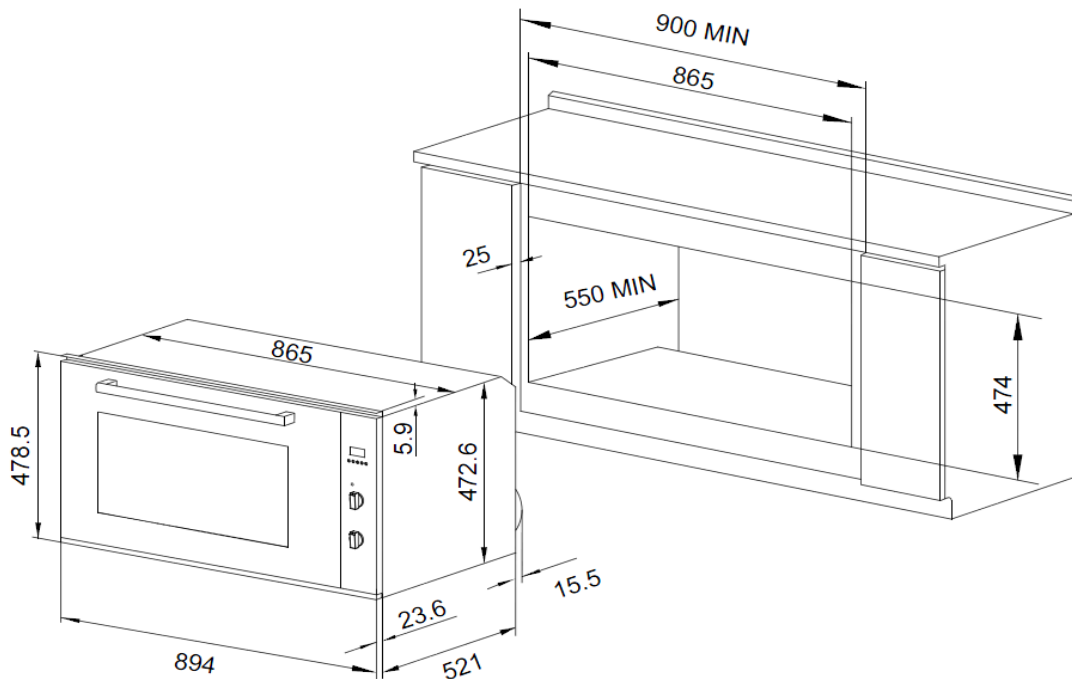



Electrical Connection

Ovens equipped with a three-pole power supply cable are designed to operate with an alternating current . The earth wire for the appliance is yellow-green in color.

Ensure that all connections are tight and secure

To install the cable, proceed as follows:

1. Remove the wire clamp screw and the three contact screws **L-N-** 
2. Fasten the wires beneath the screw heads using the following color scheme: **Blue (N) Brown (L) Yellow-Green (E)** 
3. Fasten the supply cable in place with the clamp and close the cover of the terminal board .

Connecting the supply cable to the mains

When connecting the cable directly to the mains, install an omni-polar circuit breaker with a minimum - contact opening of 3 mm between the appliance and the mains. The omni-polar circuit breaker should be sized according to the load and should comply with all New Zealand standards and regulatory requirements.

The supply cable should be positioned so that it cannot be in contact with any hot parts of this appliance. Care should be taken that the cord is not folded or damaged during installation.

Before making the connection, check that:

- The appliance is correctly earthed.
- Terminal block connections are tight and secure.
- The specifications indicated on the data plate correspond to those of the electrical mains system of the home.
- The electrical capacity of the system and sockets will support the maximum power of the appliance, as indicated on the data label.
- The plug and socket (if used) are easily accessible.

SERVICE AND PARTS

Before leaving the factory, this appliance was tested and adjusted by specialist skilled staff to give the best operating results. Any subsequent necessary repairs or adjustments must be carried out with the greatest of care and attention by authorised personnel. For this reason, we strongly advise you to contact Parmco Service Department, specifying the nature of the problem, the model and serial number of the appliance. This data is provided on the data label.

DISPOSAL

Parmco has a commitment to being environmentally responsible. To avoid potential negative impacts on the environment please ensure that this appliance is disposed of correctly. This product must not be treated as household waste. Instead it should be handed over to an appropriate collection point for recycling of electrical, electronic and steel components. Disposal should always be carried out in an environmentally appropriate manner. For more detailed information about treatment, recovery and recycling of this product, please contact your local City Council office.

TECHNICAL DATA

Model	PPOV-9S-48	
Power Source	240V ~ 50/60Hz	
Volume (usable capacity)	105 L	
Output Power	3166-3660 W	
Weight	Net Gross	51 kg 58.5 kg
Dimensions (W x H x D)	Outside Cutout	894 x 478.5 x 560mm 865 x 474 x 550mm
Company	Parmco Appliances	
Company's address	519 Mt wellington Highway Pakuranga, Auckland	