

PARMCO

Installation and Operating Instructions

Model:

AR 900-GAS GAS-1

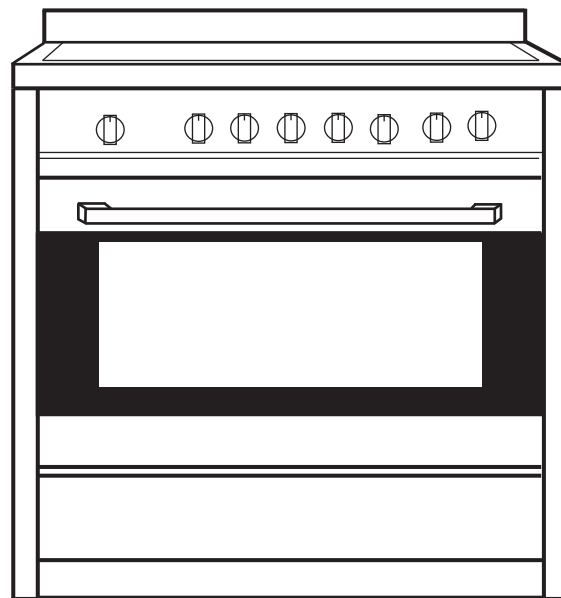

For your convenience, we recommend to
attach the serial number label HERE.

As part of Parmco Appliances commitment to improving and updating product ranges, we reserve the right to alter, change and update technical specifications and appearance attributes of all Parmco Appliances products. E&OE.

727614112023

Inspiring kitchens, entertaining homes

Parmco Appliances extended 7 year warranty



The Warranty:

- This appliance is intended for domestic use in the owners' home. Use of the appliance for commercial purposes will limit the warranty period (please see Parmco website for commercial details).
- Subject to the terms and conditions contained within this warranty, if the product is not of Acceptable Quality (as defined in the Consumer Guarantees Act) within 7 years of the date of original purchase, then Parmco Sales undertakes to repair or, at its sole discretion, replace the product.
- The warranty does not cover the costs of transport, mileage or travelling time if the product is located beyond 30km of a recognised Service Agent.
- This warranty is offered as an extra benefit, and does not affect other legal rights, which can not be modified or excluded by agreement.
- This warranty only applies to goods supplied and installed in the North and South Islands of New Zealand.
- The provisions of this warranty are in addition to the rights and remedies available to consumers under the Consumer Guarantees Act 1993.

Product _____ Date of purchase _____
Serial Number _____
Dealer / Retailers Name _____

Please retain this Warranty card together with receipt or other proof of purchase date when seeking service during the warranty period

Please contact Parmco at 09 573 5678 if your appliance needs servicing under warranty. Please have your model number and proof of purchase ready. Warranty repairs must be authorized by Parmco.

The Warranty is not valid:

- If the product is not installed and operated in accordance with the operating instructions.
- If the product is not installed to comply with the electrical, gas, plumbing and other Regulations and Codes of Practice in New Zealand.
- If the product is operated on voltages or frequencies outside the normal range for domestic appliances in New Zealand.
- If the product is not used in normal domestic use, or if it is used in a business as defined in the Consumer Guarantees Act.
- If any serial number has been removed or defaced.
- If proof of date of purchase is not supplied, except at the sole discretion of Parmco Sales. Proof of purchase can be for the product itself, or if installed with a kitchen or house then proof of purchase can be from a Parmco reseller of products supplied by Parmco.
- If the products are purchased in a second hand condition from other parties (including but not limited to TradeMe, Sella, etc.)

Liability under this warranty will not be accepted for:

- Wear and tear caused by normal domestic use of the product.
- Damage in transport.
- Damage caused to the product by neglect, abuse, negligence, wilful act or misuse.
- Any costs associated with the repair, replacement, removal or reinstallation of products installed in a damaged condition.
- Any defect caused by accident, misuse, neglect, tampering with or unauthorised modifications of the appliance or any attempt at internal adjustment or repair by any person other than an Authorised Service Agent.
- Service calls that relate principally to the following:
 - Instruction on how to use the product.
 - Repair or replacement of house fuses, electrical wiring, gas fitting or plumbing.
 - Normal or scheduled maintenance including blocked filters or ducting.
 - Consumable items such as light bulbs.
 - Any damage to hobs caused by spills when cooking.
 - Any breakage or damage of glass items.
 - Any damage caused by non recommended product used for cleaning, maintaining, lubricating or similar.
- Any aspect relating to the installation of the product, or damage caused during installation including blocked access for repair.
- Any third party (including reseller) or consequential loss or damage (direct or indirect) however arising.



Dear Valued Customer,

Thank you and congratulations on purchasing your new Parmco appliance.

All Parmco products are made to the highest quality and design standards. We are sure you will enjoy your new appliance.

As a note, please read through these instructions carefully. These will assist you in gaining a complete understanding of the functions and features offered by your appliance. Please take special note of all detailed technical information and installation instructions. It is essential that you follow these instructions to ensure the safety and reliability of this appliance.

Furthermore, not using appropriate personnel to install this appliance may affect any future warranty claims lodged, so please check with Parmco Appliances before any installation is carried out.

We hope you enjoy your new appliance. If you would like to find out more about this product or any other products in Parmco's extensive range, visit us online at www.parmco.co.nz.

Regards,
The Parmco Team

PARMCO

Inspiring kitchens, entertaining homes

CONTENTS

1. Instructions for use	2
2. Instructions for disposal	3
3. Installing the appliance.....	4
4. Adaptation to different types of gas.....	7
5. Final operations	9
6. Control panel	10
7. Using the cooking hob	11
8. Using the oven	12
9. Accessories.....	15
10. Cleaning and maintenance	15
11. Additional maintenance	17

INSTALLATION MUST BE CARRIED OUT BY A QUALIFIED TECHNICIAN, WHO MUST CARRY OUT AN ADEQUATE INSPECTION OF THE GAS SYSTEM, INSTALL THE APPLIANCE, SET IT TO FUNCTION, AND CARRY OUT AN INSPECTION TEST.

Oven Performance:

It is important to remember that this oven may perform differently to the way your previous appliance worked. To obtain best cooking results, please experiment with temperature, rack height, and cooking times.

Steam and Condensation:

Often owners of new ovens will see a higher level of steam and condensation than they are used to in their previous appliance. This is normal and contributes to keeping the food moist during cooking. The amount of condensation will depend on the type of food (fresh, defrosted, frozen) being cooked and the cooking style (water in the roasting dish). Climatic conditions also contribute to the generation of condensation (outside temperature vs inside temperature). When food is heated it produces steam in the same way a boiling kettle does. When steam comes into contact with the oven door glass it will condensate and produce droplets. To reduce condensation, ensure that the oven is well heated before placing food in the oven cavity. Oven pre-heating is necessary before any cooking! It is normal for steam to escape the oven when opening the door. To reduce the build-up of condensation pre heat the oven for longer periods and occasionally open the door and carefully wipe away the condensation. Adjusting your cooking practices will also ensure a minimum build-up of condensation.

1. INSTRUCTIONS FOR USE

- This manual is an integral part of the appliance and therefore, it must be kept in its entirety and in an accessible place for the whole working life of the cooker. We advise reading this manual and all the instructions therein carefully before using the cooker.
- Installation must be carried out by qualified personnel in accordance with the regulations in force.
- This appliance is intended for domestic uses.
- The appliance has been built to carry out the following functions: cooking and heating up food. All other uses are considered improper. The manufacturer declines responsibility for all improper use.
- Do not discard packaging along with normal waste. Separate the various waste materials and take them to the nearest selective waste collection centre.
- All electrical systems must be grounded according to local regulations.
- The plug, the power supply cable, and its socket must be of the same type and conform to regulations.
- The socket must be accessible after the appliance is built in. Never disconnect the plug by pulling on the cable.
- If the power supply cable is damaged, contact a qualified technician immediately to replace it.
- Always check that the control knobs are in the off position when you finish using the appliance.
- Never place flammable objects in the oven.
- The identification plate with the technical data and serial number is in a visible position inside the storage compartment. The plate must not be removed.
- Never place pans that do not have a flat and smooth bottom on the cooking hob.
- Never use pans or griddle plates that extend beyond the outside edge of the hob.
- During use, the appliance becomes very hot. Take care not to touch the heating elements inside the oven.
- The appliance is intended for use by adults. Do not allow children to go near or play with the appliance.
- When the grill is working, the accessible parts can become very hot. Keep children at a safe distance.
- If the appliance is placed on a pedestal, it must be installed so that it cannot slide off.
- If the appliance is installed on motor vehicles (for example, campers, caravans, etc.), they must only be used when the vehicle is stopped.
- Install the product so that there is no possibility of making contact with pans on the cooking hob when opening drawers and doors of units.
- This appliance may not be used by people (including children) with reduced physical and mental capacity, or lacking in experience in the use of electrical appliances, unless supervised or instructed by adults responsible for their safety.
- This appliance is marked according to the European Directive 2002/96/EC on waste electrical and electronic equipment (WEEE). This guideline is the frame of a European-wide validity of return and recycling on waste electrical and electronic equipment.
- Before the appliance is put into operation, all protection films applied inside or outside must be removed.
- This appliance should be installed in accordance with the regulations in force and only in a well ventilated space.



The manufacturer declines all responsibility for damage to persons or things caused by not following the above instruction, tampering with any part of the appliance, or by the use of non-original spares.

2. INSTRUCTIONS FOR DISPOSAL

Our household appliances are packaged using only non-pollutant, environmental-friendly, recyclable materials. Please help by disposing of the packaging correctly. Find the correct address of collection, recycling and disposal centres from your local organizations.

Never leave all or part of the packaging lying around.

Your old appliance also needs to be disposed of correctly. Correct disposal means intelligent recycling of valuable materials.

Before disposing of your appliance, it is important to remove doors and leave shelves in position as for use to ensure that children cannot be accidentally trapped inside during play. It is also necessary to cut the interconnecting cable to the power supply network, removing it along with the plug.

DO NOT DISCARD PACKAGING IN THE HOME ENVIRONMENT. SEPARATE THE VARIOUS WASTE MATERIALS AND TAKE THEM TO THE NEAREST SELECTIVE WASTE COLLECTION CENTRE.

INFORMATION FOR USERS



Pursuant to Directives 2002/95/EC, 2002/96/EC and 2003/108/EC relating to the reduction of the use of hazardous substances in electrical and electronic appliances, as well as to the disposal of refuse. The crossed out bin symbol on the appliance indicates that the product, at the end of its useful life, must be collected separately from other refuse. Therefore, the user must consign the product that has reached the end of its working life to the appropriate selective collection centres for electrical and electronic refuse. Adequate selective collection for the subsequent forwarding of the decommissioned product to recycling, treatment and ecologically compatible disposal contributes to avoiding possible negative effects on the environment and on health and promotes the recycling of the materials of which the appliance consists. The illicit disposal of the product by the user results in the application of administrative sanctions.

3. INSTALLING THE APPLIANCE

The appliance must be installed by a qualified technician and according to the regulations in force. This appliance could be freestanding or built-in. It can also be installed next to a wall which is higher than the appliance, with a minimum distance of 150mm from the side of the appliance, as shown in the drawing below. Any wall cupboards or shelves must be at a distance of at least 750mm above the work surface.

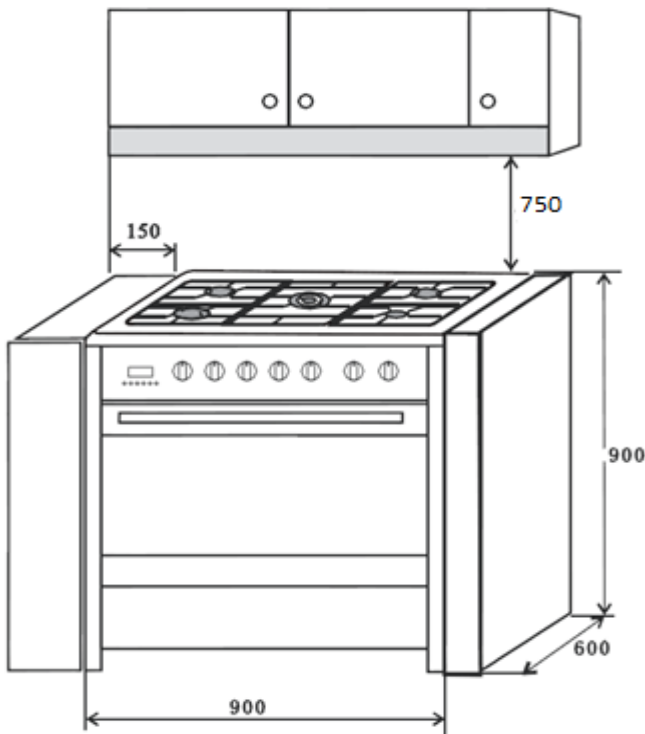

AR 900-GAS GAS-1

The cooker is supplied with an anti-tilting chain to prevent the appliance from tilting forward and any accidental damages to the gas pipe. Take the

expansion with the hook and make an adequate hole in the wall behind, at the same height as the chain fixation area. Insert the plug into the hole and then screw in the hook until it is fixed to the wall. Fix the chain to the hook. Adjust to the level of the cooker inserting the foot provided with some models.

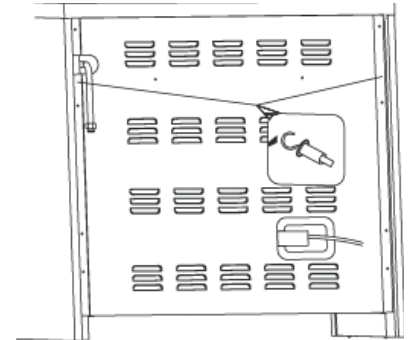

WARNING:

- Prior to installation, ensure that the nature of the gas, the gas pressure, and the adjustment of the appliance are compatible.
- The adjustment conditions for this appliance are as stated on the data plate.
- Check that this appliance is not connected to a ventilation/extraction device. It shall be installed and connected in accordance with current installation regulations, with particular attention to the relevant ventilation requirements.

3.1 Electrical connection

Make sure that the voltage and the cross-section of the power supply line match the specifications indicated on the identification plate positioned in the storage compartment. Do not remove this plate for any reason.

If the appliance is connected to the power supply network by a fixed connection, install a multipolar cut-out device on the power supply line with a contact opening distance equal to or greater than 3mm near the appliance and in an easily reachable position.

Connection to the power supply network may be fixed or using a plug and socket. With the latter option, the plug and socket must be suitable for the cable and conform with the regulations in force. Regardless of the type of connection, it is compulsory that the appliance is earthed. Before connection, make sure that the power supply line is suitably earthed. Avoid the use of adapters and shunts.

For operation on 220-240V: use a three-pole cable of H05RR-F or H05V2V2-F type:

3 x 1.0mm² for 60cm models

3 x 1.5mm² for 90cm models

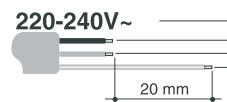

WARNING: The values indicated above refer to the cross section of the internal conductor. Please note that only some of the 90cm models can be connected with two or three phases.

3.2 Room Ventilation

The room containing the appliance should have an air supply in accordance with the standards in force. The room where the appliance is installed must have enough air flow as required for the regular combustion of gas and by the necessary air exchange of the same room. The air vent, protected by grills, must be suitably dimensioned in compliance with the current regulations and positioned so that no part of it is obstructed. The cooker must be kept adequately ventilated in order to eliminate the heat and humidity produced by cooking. After prolonged use, it is recommended to open a window or to increase the speed of any ventilators.

3.3 Extraction of the products of combustion

Extraction of the products of combustion must be ensured by means of hoods connected to a natural draught chimney whose efficiency is assured or by forced extraction. An efficient extraction system requires precision planning by a specialist qualified in this area and must comply with the positions and distances indicated by the regulations.

3.4 Connection to gas

Installation of the rubber steel hose must be carried out so that the steel hose length is no greater than 1.5 m. Make sure that the steel hose is not squashed and will not come into contact with moving parts.

Verify that all the following conditions are met:

- The steel hose is fixed to the steel hose connection with safety clamps.
- No part of the steel hose is in contact with hot walls (max 50°C).
- The steel hose is not under traction or tension and has no tight curves or twists.
- The steel hose is not in contact with sharp objects or sharp corners.
- If the steel hose is not perfectly airtight and leaks gas, do not try and repair it. Replace it with a new steel hose and verify that the hose is not beyond its life cycle (screen printed on the hose).

 The tightening torque between the connections that incorporate the gasket must not exceed 10mm.

Gas Connection

Connection with copper pipe:

The connection to the gas supply mains must be made so that no stresses or strains of any kind are applied to the appliance. The connection can be made using the adapter unit D with two conical elements, noting to always fit the gasket C.

Connection with steel hose:

Use only continuous-wall stainless steel hoses that are compliant with the relevant regulations. Always fit the gasket C between the fitting A and the hose E.

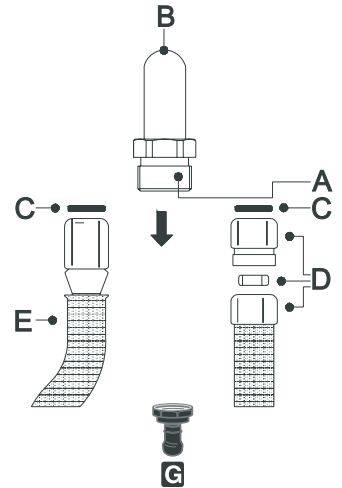

When connecting to a hose, ensure that the total length of the pipeline is not more than 1.5m, as well as ensure that the hoses are not crushed and will not touch moving parts.

 The hose connector G illustrated in the diagram is not supplied with the appliance. Only use hose connectors that are compliant with local standards.

4. ADAPTATION TO DIFFERENT TYPES OF GAS

Before carrying out the following operations, disconnect the appliance from the electrical supply.

The appliance is preset for natural gas G20 (2H) at a pressure of 20 mbar. For other gas types, the burner nozzles must be changed and the minimum flame adjusted on the gas taps. To change the nozzles, proceed as described in the following sections.

4.1 Replacement of nozzles on the cooking hob

1. Remove the pan stands, as well as all the caps and flame-spreader crowns.
2. Unscrew the burner nozzles with a 7mm socket wrench.
3. Replace the burner nozzles according to the type of gas to be used (see section 4.2 Burner and nozzle characteristics table).
4. Replace the burners in the correct position.

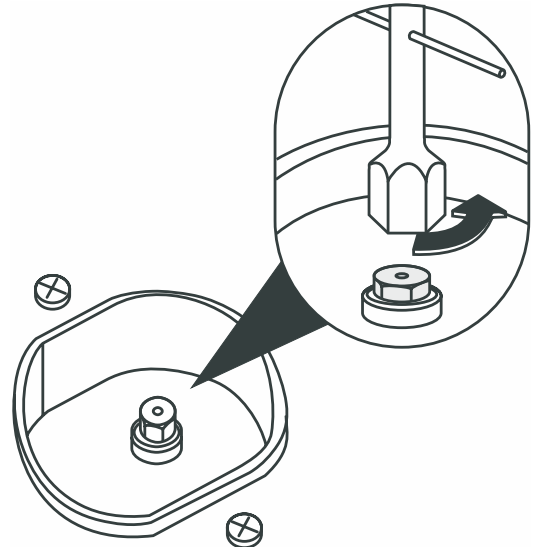

4.2 Burner and nozzle characteristics table

Natural Gas 2kPa					
Product Code	Burner type	No. of burners	Injector size in mm		Nominal Gas consumption per burner
			Natural Gas	Primary aeration Natural Gas	
AR 900-GAS GAS-1	Auxiliary	1	0.72	-	3.6 MJ/h
	Semi Rapid	2	0.97	-	6.3 MJ/h
	Rapid	1	1.18	-	10.8 MJ/h
	Wok	1	1.49	-	13.68 MJ/h
	Grill (top gas)	1	1.22	6 x 18mm, 2 sides	10.08 MJ/h
	Oven (bottom gas)	1	1.3	12 x 18mm, 2 sides	13.68 MJ/h
Universal LPG 2.75kPa					
Product Code	Burner type	No. of burners	Injector size in mm		Nominal Gas consumption per burner
			LPG Injector size	Primary aeration LPG	
AR 900-GAS GAS-1	Auxiliary	1	0.50	-	3.6 MJ/h
	Semi Rapid	2	0.65	-	6.3 MJ/h
	Rapid	1	0.85	-	10.8 MJ/h
	Wok	1	0.95	-	13.32 MJ/h
	Grill (top gas)	1	0.82	6 x 18mm, 2 sides	10.08 MJ/h
	Oven (bottom gas)	1	0.98	12 x 18mm, 2 sides	13.68 MJ/h

4.3 Arrangement of the burners on the cooking hob

AR 900-GAS GAS model

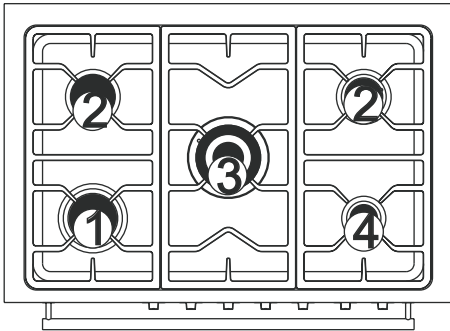

BURNERS

1. Rapid
2. Semi rapid
3. Triple ring (wok)
4. Auxiliary

4.4 Oven burner adjustment

To adjust the oven burner, open the oven door, remove the oven base and its rack, then lift up the oven surface and pull it outwards. Then follow the steps below.

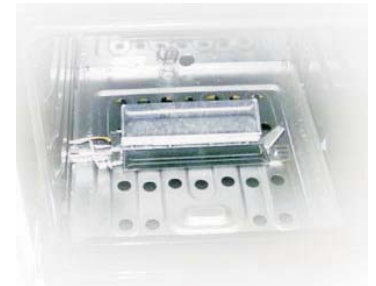

Replacing the oven burner nozzle

Loosen the oven burner fixing screw A. Push the burner B towards the right until the nozzle is accessible. Using a 13 socket spanner, replace the nozzle with a new nozzle suitable for the type of gas to be used (see section 4.2 Burner and nozzle characteristics table).

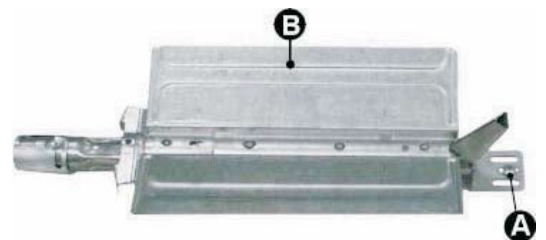

Primary air adjustment for the oven burner

Loosen the adjustment screw A of the air regulation sleeve. Turn the adjustment sleeve to the position that corresponds to the type of gas to be used, referring to the table below. Tighten the adjustment screw and restore the seals.

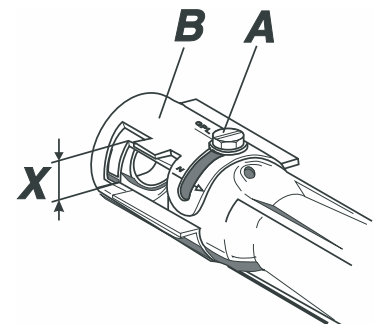

	NATURAL GAS	G 30/31 (LPG)
X=	5 mm	10 mm

When the operation is completed, reassemble the burner correctly.

5. FINAL OPERATIONS

After replacing the nozzles, reposition the flame-spreader crowns, the burner caps and the pan stands. Following the adjustment to a new type of gas, replace the gas adjustment label fixed to the appliance with the one corresponding to the new gas. The label is inserted in the pack together with the nozzles.

5.1 Adjusting the minimum setting for hob burners (NG)

Light the burner and turn it to the minimum position. Remove the gas tap knob and turn the adjustment screw on the side of the tap rod until the correct minimum flame is achieved. Refit the knob and make sure that the burner flame is stable, so that turning the knob rapidly from the maximum to the minimum position will not cause the flame to go out. Repeat the operation on all the gas taps.

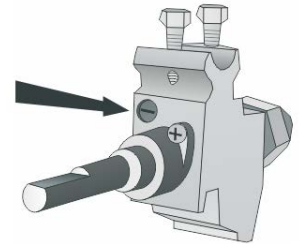

Note: keep the knob at minimum level for a few seconds to keep the flame lit and to activate the safety device.

5.2 Adjusting the minimum setting for hob burners (LPG)

In order to adjust the minimum with liquid gas, the screw on the side of the tap rod must be fully tightened clockwise all the way. The bypass diameters for each individual burner are shown in section 4.2 Burner and nozzle characteristics table. When the adjustment is completed, restore the sealing of the bypasses with paint or other material.

5.3 Adjusting the minimum setting for the oven burner

Light the burner and turn it to the minimum position.
Let the oven reach temperature.
Remove the gas tap knob and turn the adjustment screw on the side of the tap rod until the correct minimum flame is achieved. Refit the knob and make sure that the burner flame is stable, so that turning the knob rapidly from the maximum to the minimum position will not cause the flame to go out. Repeat the operation on all the gas taps.

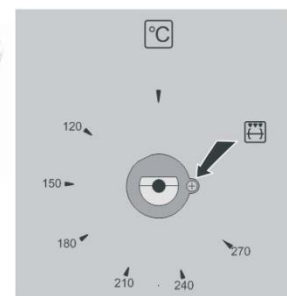
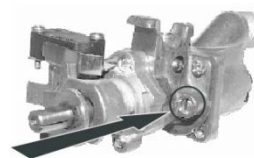

Note: The low flame automatically reduces when at temperature. Using an independent temperature test device will ensure accurate temperatures while adjusting low flame.

6. CONTROL PANEL

All the cooker controls are on the front panel. **AR 900-GAS GAS**

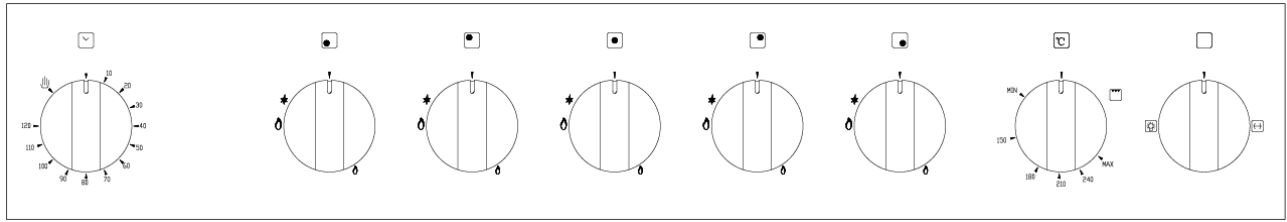

OVEN THERMOSTAT KNOB



TIMER KNOB



FRONT LEFT-HAND BURNER



REAR LEFT-HAND BURNER



FRONT CENTRAL BURNER



REAR CENTRAL BURNER



CENTRAL BURNER



REAR RIGHT-HAND BURNER



FRONT RIGHT-HAND BURNER

Hob burners control knob

To light the flame, press the knob and turn it counter-clockwise to the minimum flame symbol. To adjust the flame, turn the knob to the zone between the maximum and minimum setting. To turn off the burner, turn the knob to the off position.

Timer knob

To use the timer, the buzzer must be set by turning the knob in a clockwise direction. The numbers correspond to minutes (maximum 120 minutes). Adjustment is progressive and intermediate positions between the figures can be used. The end of the timer does not interrupt the operation of the oven.

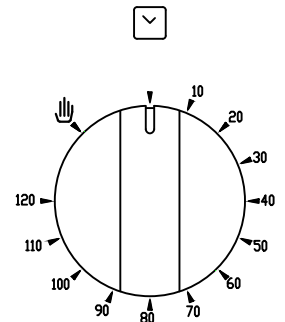

Gas oven thermostat knob

This knob lights the gas burner inside the oven. The cooking temperature is selected by turning the knob counter-clockwise to the desired temperature setting. Also refer to section 8, Using the gas oven.

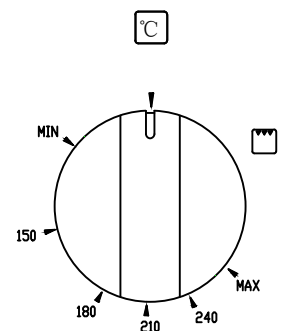

7. USING THE COOKING HOB

7.1 Lighting the hob burners



Before lighting the hob burners, check that the flame-spread crowns are correctly in place with their respective burner caps, making sure that the holes A in the flame-spreaders are aligned with the plugs and thermocouples. The optional trivet B is for use with woks.

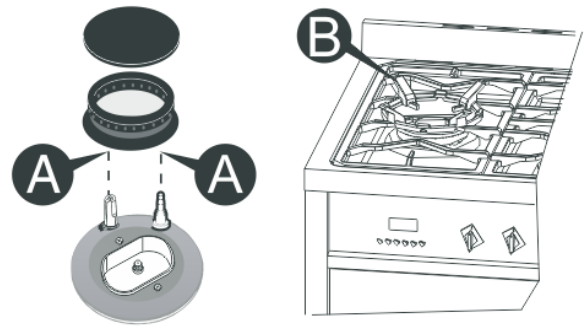

The burner controlled by each knob is shown above the knob. The appliance is equipped with an electronic ignition device. Simply press the knob and turn it counter-clockwise to the maximum flame symbol until it lights. If it does not light in the first 15 seconds, switch the knob to the off position and wait at least 60 seconds before trying to light it again.

Once the burner is lit, keep the knob pressed for a few seconds to give the thermocouple time to heat up. If the burner goes out when the knob is released, it may be that the thermocouple has not heated up sufficiently. Wait a few moments and repeat the operation, keeping the knob pressed for a longer time.

If the burners go out accidentally, a safety device will be tripped, cutting off the gas supply even if the gas tap is open. In this case, turn the knob to the off position and wait at least 60 seconds before trying to light the burner again.

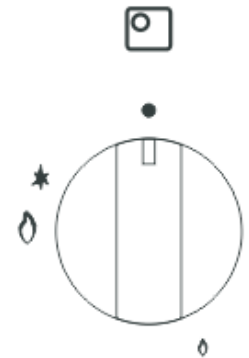

7.2 Practical hints for using the hob burners

For better burner efficiency and to minimize gas consumption, use pans with lids and of suitable size for the burner so that the flames do not reach up the sides of the pan. Once the contents come to boil, turn down the flame to prevent the liquid from boiling over. To prevent burns or damage to the hob during cooking, all pans or griddle plates must be placed within the perimeter of the hob. All pans must have smooth, flat bottoms. Take the greatest care when using fats or oils as they may catch fire if overheated. If the flame accidentally goes out, turn off the control knob and wait at least 60 seconds before trying to relight the burner.

7.3 Cooking pan diameters

Burner	Minimum pan diameter (mm)	Maximum pan diameter (mm)
Auxiliary	90	160
Semi-rapid	130	180
Rapid	150	260
Triple ring (Wok)	210	260

8. USING THE OVEN

8.1 Warnings and general advice

When using the oven for the first time, heat it at the maximum temperature for long enough to burn off any oily residues left by the manufacturing process, which might contaminate foods with unpleasant smells.



WARNING: the gas oven must be lit with the oven door open. The oven is equipped with a safety system that blocks ignition of the burner if the door is closed. If you make a mistake in the lighting procedure, open the oven door and wait a few minutes before trying to light it again.

While cooking desserts and vegetables, condensation from the bottom of the door could occur. This is a natural physical phenomenon which mainly occurs when preheating has not taken place. To avoid this, open the door a couple of times while cooking, taking great care.

To prevent the steam from the oven creating problems, open the door in two stages – approximately 5cm open for 5 seconds, then fully open. Try to minimize the length of time the door is open to prevent the temperature in the oven falling and ruining the food.

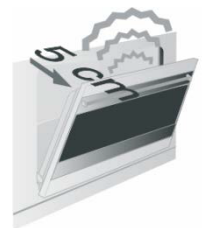

8.2 Using the gas oven

Electronic spark ignition

Open the oven door fully, press the thermostat knob and turn it counter-clockwise to the maximum temperature. The electrical spark ignition is activated automatically. When the oven is lit, keep the knob pressed down for a few seconds to allow the thermocouple to heat up. If the burner does not ignite after 15 seconds, stop the attempt to light it, open the door completely, and wait at least 60 seconds before trying to light it again.

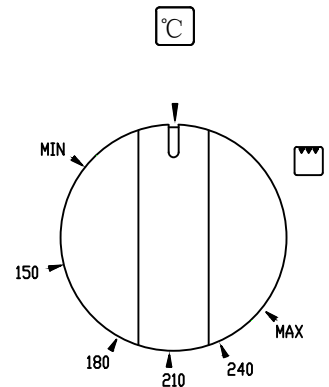

If the burner is accidentally extinguished, the safety valve will be activated to interrupt the flow of gas. To light it again, turn the knob to the off position and wait for about 60 seconds, then relight the gas using normal procedures.



The use of a gas cooking appliance produces heat and moisture in the room in which it is installed. Ensure that the kitchen is well ventilated: keep natural ventilation holes open or install a ventilation system. Prolonged intensive use of the appliance may call for additional ventilation, such as open windows or increasing the extraction speed of the ventilation system.

8.3 Using the gas grill/roisserie

You must first turn off the oven burner by moving the knob to the off position, then turn the selector to the grill position. It is not possible to operate the gas oven and the grill/roisserie at the same time.

Once the oven is turned on, leave it to heat up for 5 minutes before placing foods inside. Use the oven tray to collect any cooking juices. The foods to be cooked should be placed on the oven rack, on the corresponding runner following the guidelines as below.

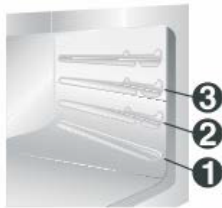
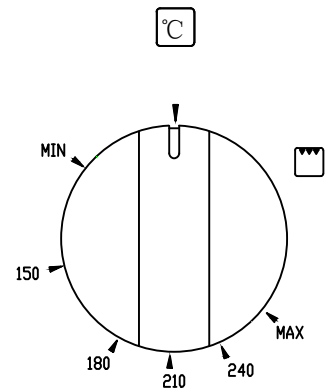

FOODS	RACK ON THE SHELF
Flat, thin pieces of meat	3
Rolled roasts	2 - 3
Poultry	2 - 3

To use the rotisserie for the AR900-GAS GAS model, secure the meat on the supplied skewer using the brackets to keep it in place and balanced during cooking. Then place the skewer into its designated hole on the rack, ensuring the rack lug is fitted correctly at the opposite end.



Place the wire rack for the spit roast on the second rack from the bottom up locating the spindle into the rotisserie opening. The spindle is located at the rear left of the oven.

Place the drip tray on the bottom rack to catch any drippings during cooking..



PRECAUTIONS

Grilling processes must never last more than 60 minutes.

Keep the door closed during grill cooking operation for best result.

Accessible parts may become very hot during and after use. Keep children well away from the appliance.

During oven cooking operations, place the baking tray provided on the bottom shelf position to prevent any spillages from dripping onto the bottom of the oven.

When using the oven, remove all unused plates and racks from its interior. Do not cover the bottom of the oven with aluminium or tin foil, and do not place pans or oven plates on it as this may damage the enamel coating. If you wish to use greaseproof paper, place it so that it will not interfere with the hot air circulation inside the oven.

8.4 Storage compartment

The storage compartment is at the bottom of the cooker, underneath the oven. To open it, pull on the top of the door.



Do not open the storage compartment when the oven is on and still on. The temperatures inside it may be very hot.



Never use it to store flammable materials such as rags, paper, etc. It is intended for storing the appliance's metal accessories only.

9. AVAILABLE ACCESSORIES

The oven features 3 or 4 runners (model dependant) for positioning plates and racks at different heights.

Oven rack: for cooking food inside dishes, small cakes, roasts, or foods that require slight grilling.

Plate rack: for cooking foods which may drip.

Oven plate: useful for collecting fat form foods placed on the rack above.

Baking plate: useful for cooking cakes, pizza, and baked desserts.

Chromium-plated gripper: useful for removing hot racks and plates.

Note: not all accessories are provided on some models.



10. CLEANING AND MAINTENANCE



Before performing any operation that requires access to live parts, disconnect the power supply to the appliance.

Do not use a steam jet for cleaning the inside of the oven.

To keep the stainless steel in good condition, it should be cleaned regularly after every use of the cooker, after it has cooled down.

10.1 Ordinary daily cleaning

To clean and preserve the stainless steel surfaces, use only products that do not contain abrasives or chlorine-based acids. Pour the product on a damp cloth and wipe the surface, rinse thoroughly, and dry with a soft cloth.

Food stains or residues

Do not use metallic sponges or sharp scrapers as they will damage the surface. Use normal non-abrasive products and a wooden or plastic tool if necessary. Rinse thoroughly and dry with a soft cloth. Do not allow residues of sugary foods to set inside the oven. If left to set for too long, they might damage the enamel lining of the oven.

10.2 Cleaning the parts of the cooking hob

Pan stands

Remove the pan stands, cleaning them with warm water and non-abrasive detergent. Make sure to remove any encrustation. Replace them on the cooking hob. Contact between the pan stands and the flame can cause modifications to the enamel over time on those parts exposed to heat. This is a completely natural phenomenon and has no effect on the operation of this component.



WARNING: If using cast iron pan stands, you may find white residues on the pan stands after using pans with aluminium bases. These residues are usually caused by the pan base rubbing against the pan stand.

While they may be a little difficult to remove, do not use excessively aggressive products to clean the pan stand as it could damage its enamel surface.

Burner caps and flame spread crowns

For easier cleaning, the burner caps and the flame spread crowns can be removed. Wash them with warm water and a non-abrasive detergent, making sure to remove any encrustation. Wait until they are perfectly dry before replacing the flame spread crowns, making sure they are correctly in place with their respective burner caps. Make sure that the holes A in the flame-spread are aligned with the igniters and thermocouples.

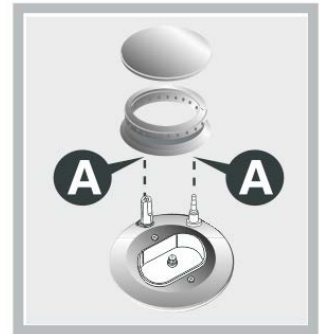

WARNING: Never wash these parts in a dishwasher. They can be left to soak with warm water and detergent.

Igniters and thermocouples

For correct operation, the igniters and thermocouples must always be clean. Check them frequently and clean them with a damp cloth if necessary. Remove any dry residues with a wooden toothpick or a needle.

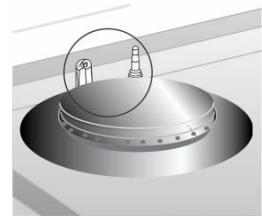

10.3 Cleaning the oven

For best oven maintenance, clean regularly after it has cooled down. Take out all removable parts, and clean the oven racks with hot water and non-abrasive detergent. Rinse and dry.



10.4 Cleaning the glass door

The glass on the door should always be kept thoroughly clean. Use an absorbent kitchen roll. For stubborn dirt, use a damp sponge and standard detergent.

11. ADDITIONAL MAINTENANCE

The oven may require extraordinary maintenance or replacement of parts subjected to wear, such as seals, bulbs, etc. The following instructions describe how to carry out these maintenance operations.

Before performing any operations that require access to live parts, disconnect the power supply of the appliance.

11.1 Lubrication of gas oven taps and thermostat

Over time, the gas taps and the gas oven thermostat may become blocked and difficult to turn. Clean them internally and replace the lubrication grease. **This operation must be carried out by a specialised and authorised technician.**

11.2 Changing the light bulb

 **WARNING: Ensure that the appliance is turned off before replacing the oven lamp/s to avoid the possibility of electric shock.**

Remove the glass cover of the lamp-holder as shown below.

Remove the lamp and replace with a lamp resistant to high temperatures (300°C) with the following characteristics.

- Voltage 220 - 240V
- Wattage: 25W
- Type: G9

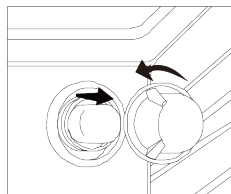

Replacement lamps are available from Parmco Appliances

11.3 Cleaning the oven door

For a more thorough clean, you have to remove the oven door.

- Open the door to the full extent (Fig.1);
- Open the lever A completely on the left and right hinge (Fig.2);
- Hold the door as shown (Fig.3);
- Gently close the door until left and right hinge levers A are hooked to part B of the door (Fig.4);

Reassemble the door by following the above procedures backwards.

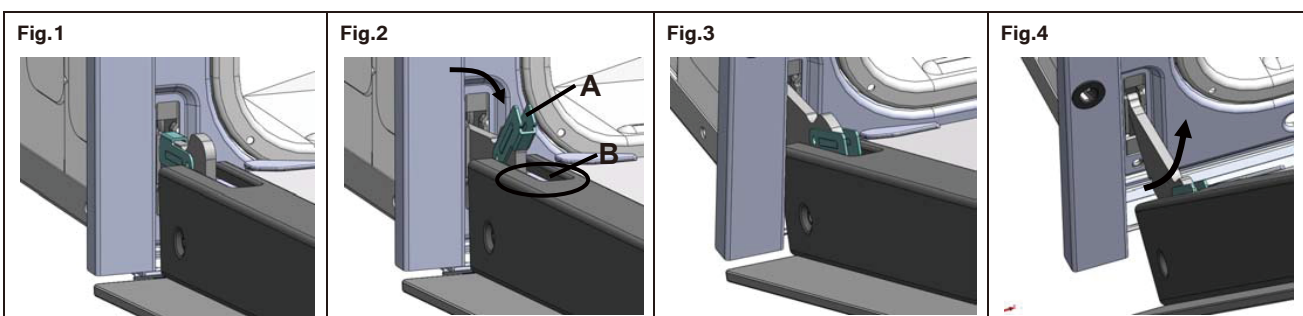

11.4 Removing the door seal

To allow thorough cleaning of the oven, the seal may be removed. Before removing the seal, remove the door as described above. Once the door has been removed, lift the tabs at the corners as shown in the figure.

