

**IMPORTANT**

It is the responsibility of the installer to ensure that the installation of this appliance complies with AS/NZS 2918



# Installation supplement for the Ethos Ares IS100 wood fire with EZC-031135 Zero Clearance Cabinet and EXA-10042 EconAir flue system

**Ethos Ares Zero Clearance Kit has been tested to and complied with AS/NZS2918:2001  
Test report # ARS 14/2684**

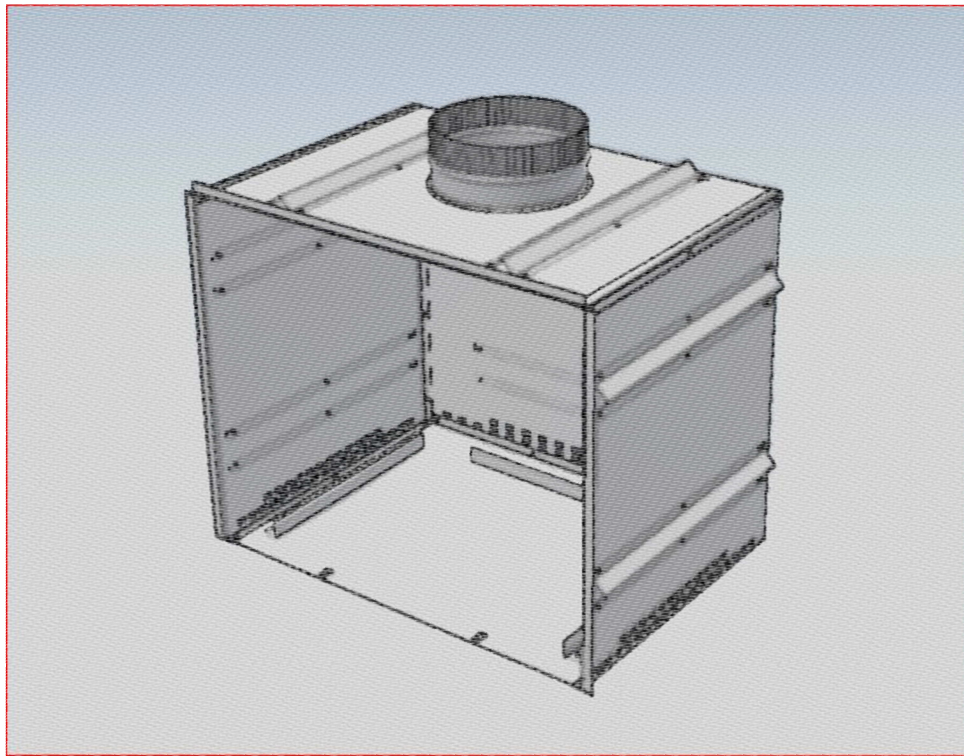

These instructions should be read in conjunction with the instruction and install documents for the Ares IS100 wood fire.

**Retain these instructions for future reference**



Following these instructions allows for the Ethos IS100 Insert wood fire to be safely installed in a timber frame wall, without the need for further heat protection beyond what is provided as part of the EZC-031135 Zero Clearance Cabinet and the EXA-10042 EconAir flue system.

**Warning:** It is critical that these instructions are followed fully and that no substitute parts are used.



Econ-Air flue system parts list:			
3	130mm x 1200mm S/S flue	1	130mm x 600mm S/S flue
2	200mm x 1200mm galv. liner	1	200mm x 600mm galv. liner
1	200mm x 1200mm galv. liner with 'Z' brackets	1	250mm x 600mm galv. liner
3	250mm x 1200mm galv. liner	1	130mm spider bracket
4	40mm x 40mm x 600mm mounting rails	1	Ethos revolving cowl (EXS-12010)
1	Ethos IS cowl base (EXS-12002)		

## Important Installation Notes

- Combustible materials must be kept to a minimum of 25mm away from all parts of the Zero Clearance Cabinet and the 250mm diameter outer flue liner. 
- Adequate ventilation must be available for cooling the Zero Clearance Cabinet. Refer installation diagram example for supplied ventilation plate mounting details on page 6. 
- If installing on combustible floor surfaces such as timber, option base panel part model EZC-031140 is required to be fitted beneath the Zero Clearance Cabinet. Further details are shown on page 4. 

## Floor Insulation Detail

The following table sets out the calculated floor protector projections required to ensure that temperatures on the exposed floor comply with the requirements of standard AS/NZS 2918:2001 for exposed floors constructed of medium heat resistant materials.

**Figure 1** Explanation of and Height (H) and Projection (P) parameters.

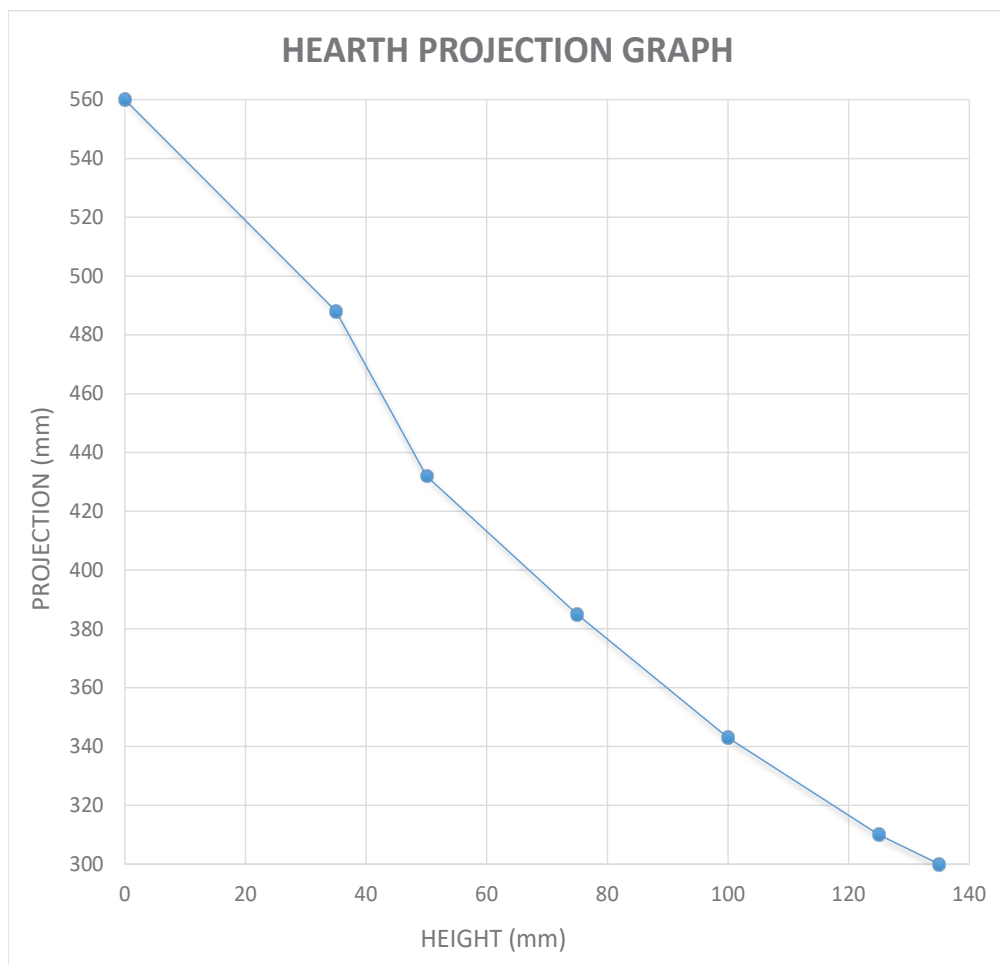
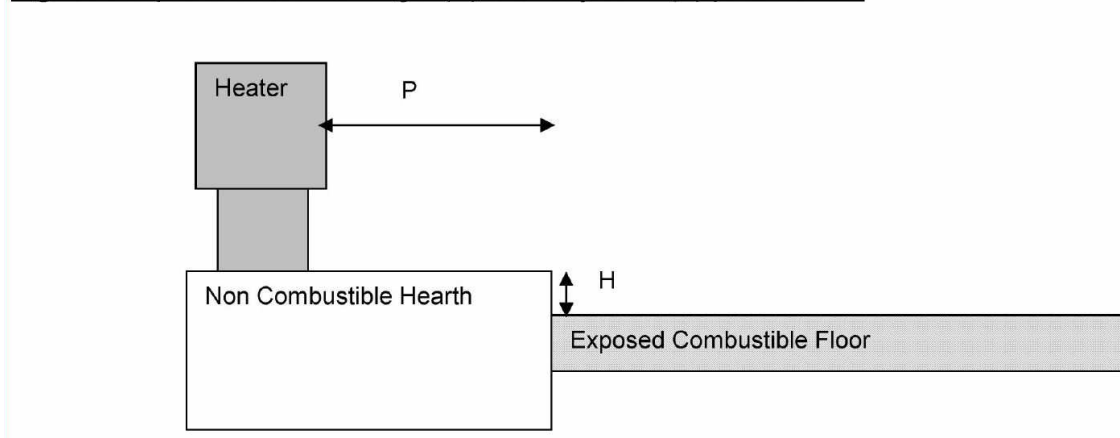

H = Height of top of Hearth above Exposed Floor (mm)	P = Projection (mm)
0	560
35	488
50	432
75	385
100	343
125	310
135	300

The EXA-10042 EconAir flue system recovers the vented heat from the Zero Clearance Cabinet and recycles it back into the fire as combustion air for added efficiency.

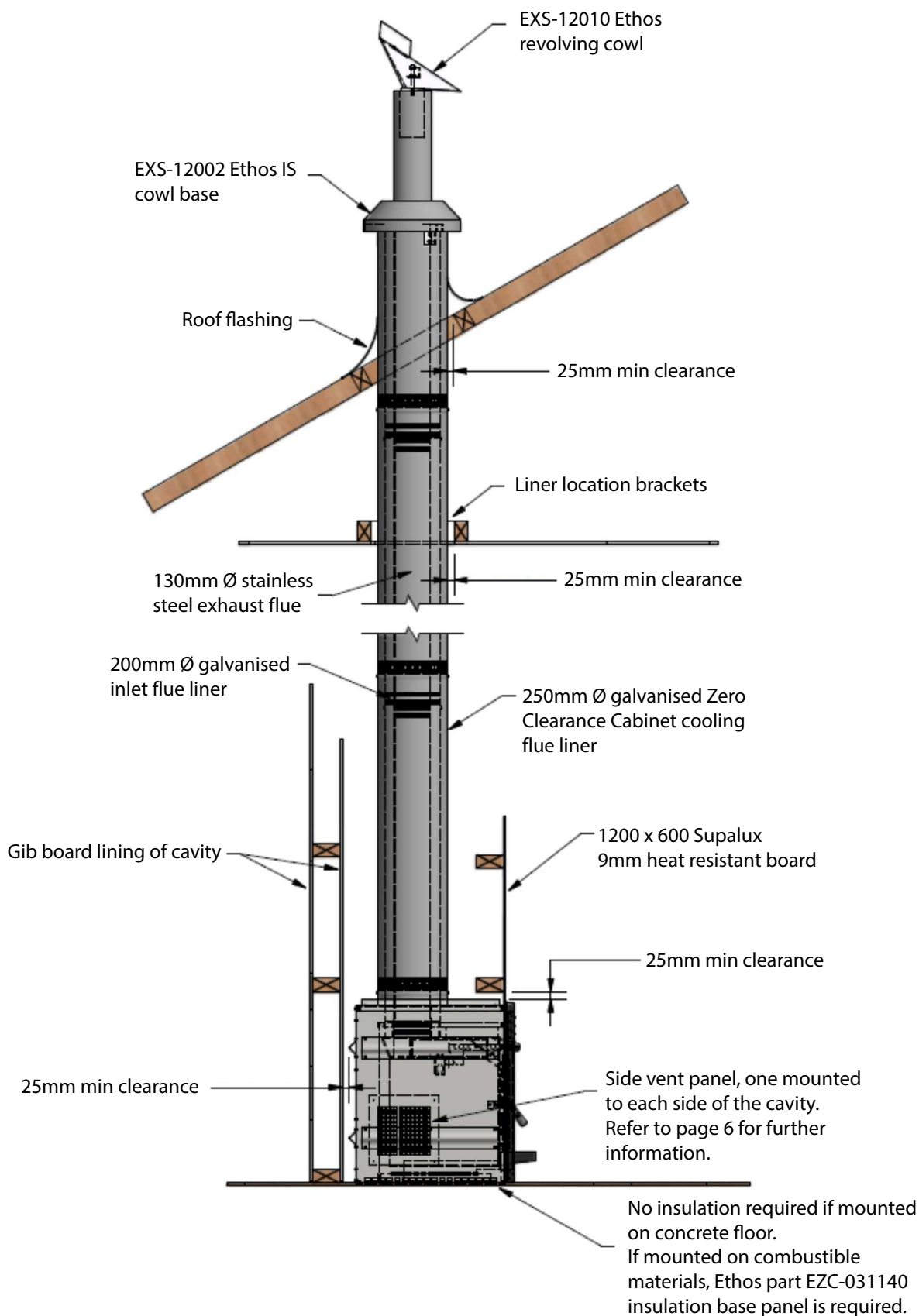

## Top View Example

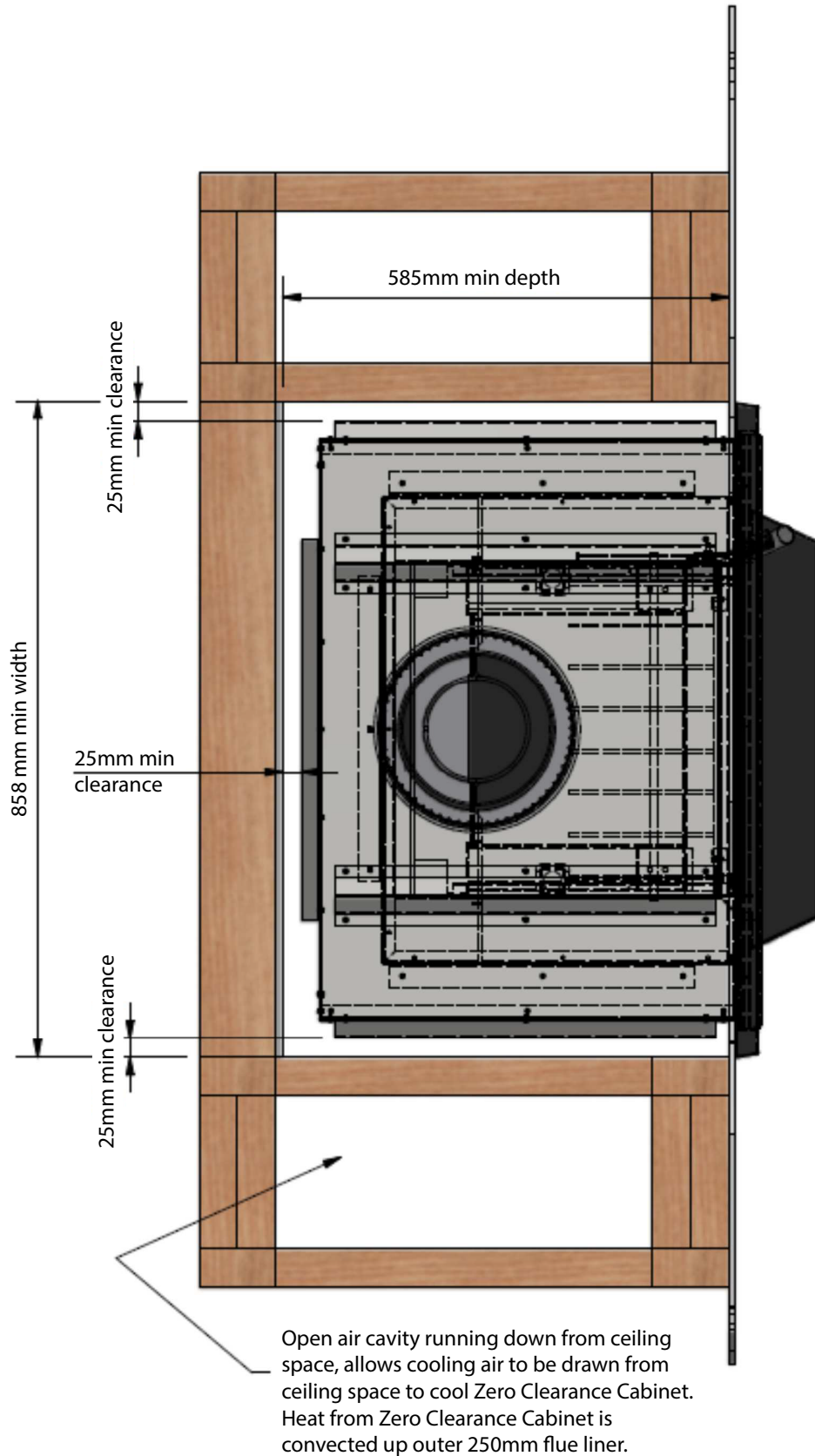

## Front 3/4 View Example with Air Cavity and Vent Plates

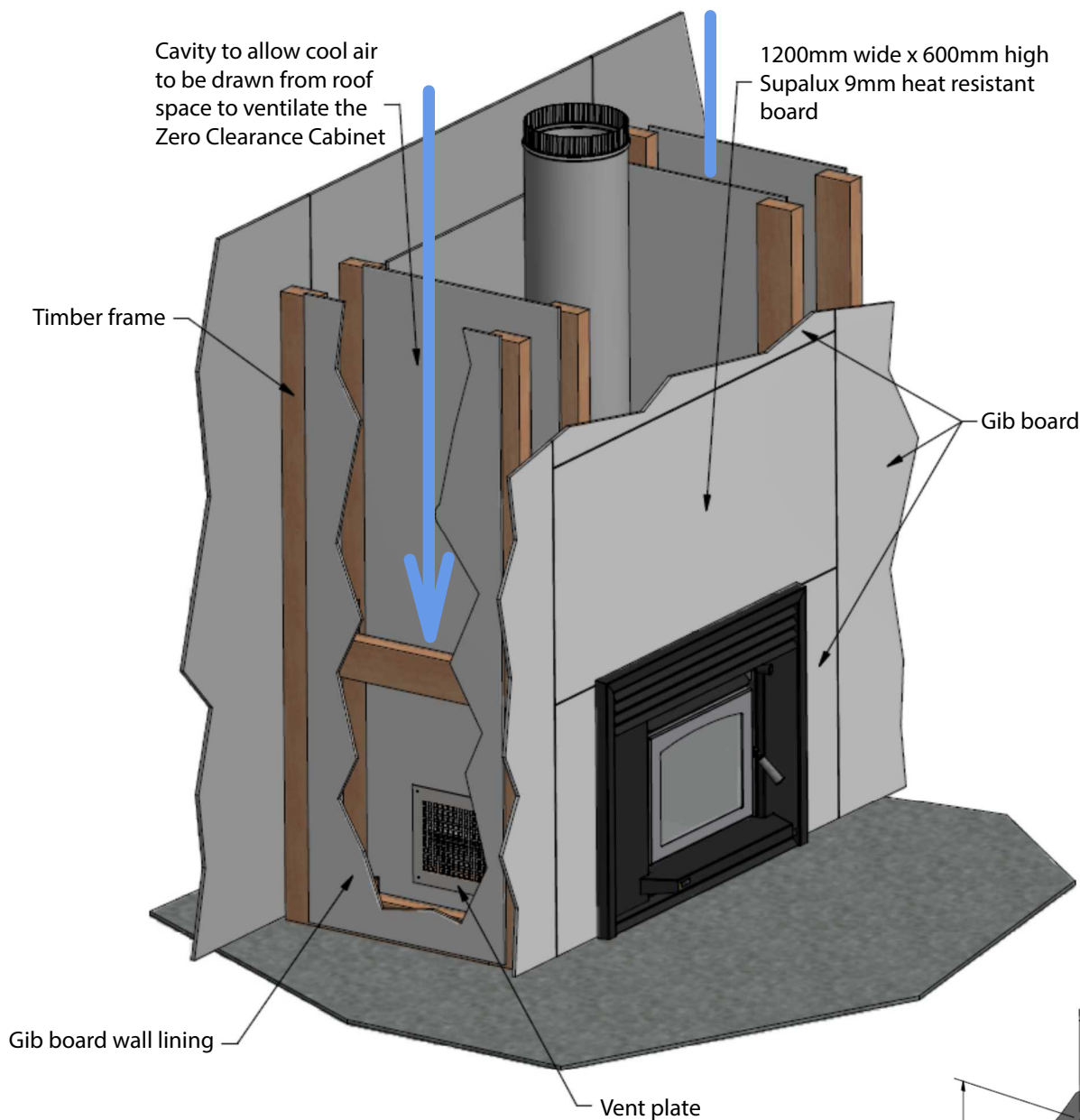

 It is essential to provide adequate ventilation to the cavity. Mount supplied ventilation plates centrally and as low as the timber frame will allow. Ensure the cavity has access to uninterrupted air supply from ceiling space.

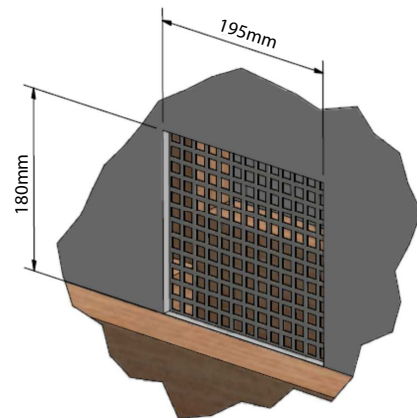

### Australia

Capisco Aust Pty Ltd  
2/281 Pacific Highway  
North Sydney, NSW 2060  
Phone (02) 8310 7304  
www.capisco.com.au

### New Zealand

Capisco Ltd  
PO Box 938, Whangaparaoa  
Auckland 0930  
Phone (09) 947 5166  
www.capisco.co.nz

### Notes/Installer/Dealer Details