



INSTALLATION & OPERATING INSTRUCTIONS

Clean Air Freestanding Wood Fires

CONTENTS

General Information	2
Specifications	2
Installation	3-7
Operation	8-9
Maintenance	10
Replacement Parts	11-12
Warranty	14-15

GENERAL INFORMATION

1. This Kent freestanding wood fire must be installed by an approved installer, ideally registered with the New Zealand Home Heating Association. Do not allow any makeshift or compromising installation methods as this could result in a house fire. This Kent freestanding wood fire must be installed according to these instructions.
2. A Building Consent from the Local Authority must be obtained before installing this wood fire, and we suggest that the Insurance Company covering building insurance be advised of the installation.
3. This Kent freestanding wood fire, when installed according to these instructions, complies with the provisions of AS/NZS 2918-2001 "Installation of Domestic Solid Fuel Burning Appliances".
4. The clearances given in these instructions are necessary to prevent overheating of nearby combustibles and drying out of the house structure. They may not be reduced without authorisation.
5. Important: Read all instructions carefully before starting installation. Failure to follow these instructions could result in a fire hazard, and may void warranty.

RETAIN THESE INSTRUCTIONS FOR FUTURE REFERENCE

Important: the installer or seller must leave these instructions with the purchaser





SPECIFICATIONS

Model	Model No.	External fire dimensions (mm)			Performance		ECAN NO *
		Width	Depth	Height	Average emissions	Average efficiency	
Cardrona	KWF295-6960	535	407	648	0.80g/kg	69%	165498
Oxford	KWF295-6961	535	407	648	0.80g/kg	69%	165500
Benmore	KWF295-6962	535	407	648	0.80g/kg	69%	165499
Signature	KWF295-6824	700	505	715	0.85g/kg	71.34%	111733
Haast	KWF295-6950	575	560	730	0.98g/kg	66%	144660
Aspiring	KWF295-6951	575	560	730	0.98g/kg	66%	144661
Murchison	KWF295-6952	575	560	730	0.98g/kg	66%	144662

* ECAN NO = Environment Canterbury authorisation number.

TABLE 1

RECOMMENDED FLUE KITS FOR KENT FREE STANDING WOOD FIRES

Description	Model No.	
Standard - 4.2m	KWF298-7005	Tested to AS/NZS 2918, Appendix F, ARS report No:02/649
Energy Saver - 4.2m	KWF298-7006	Tested to AS/NZS 2918, Appendix F, ARS report No:02/649
Sloping Ceiling - 4.2m	KWF298-7354	Tested to AS/NZS 2918, Appendix F, ARS report No:14/2718

MINIMUM INSTALLATION CLEARANCES

Wall Clearances

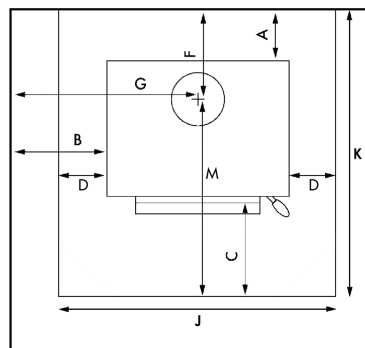

Corner Clearances

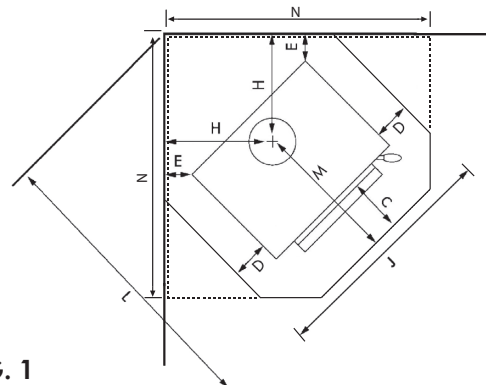

FIG. 1

Model	Model No.	Minimum Installation Clearances (with flue shield) mm								Hearth Clearances (mm)				
		A	B	C*	D	E	F	G	H	J	K	L	M	N
Cardrona	KWF295-6960	135	350	300	130	120	255	610	395	795	865	1140	585	1000
Oxford	KWF295-6961	135	350	300	130	120	255	610	395	795	865	1140	585	1000
Benmore	KWF295-6962	135	350	300	130	120	255	610	395	795	865	1140	585	1000
Signature	KWF295-6824	100	250	300	90	50	245	600	400	880	805	1120	560	1140
Haast	KWF295-6950	160	360	300	130	190	320	645	500	835	960	1340	640	1160
Aspiring	KWF295-6951	160	360	300	130	190	320	645	500	835	960	1340	640	1160
Murchison	KWF295-6952	160	360	300	130	190	320	645	500	835	960	1340	640	1160

* Fuel loading opening to end of floor protector.

TABLE 2

Single story flue installation options (side elevation)

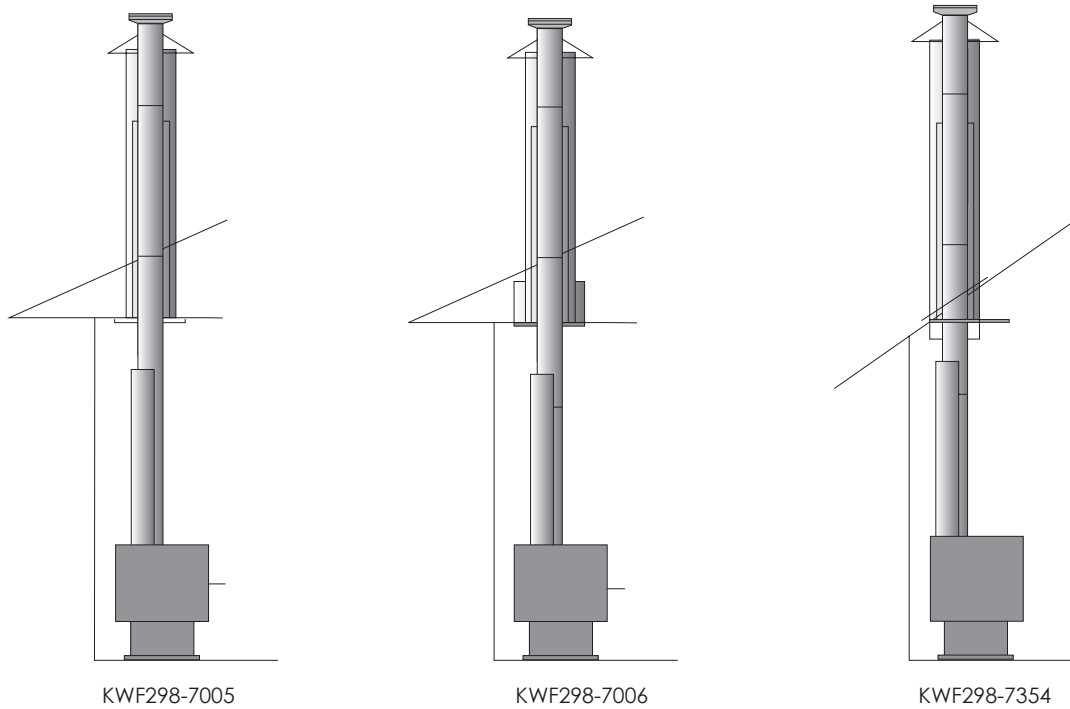

KWF298-7005

KWF298-7006

KWF298-7354

Model No.	Description
KWF298-7005	Kent standard flue kit 4.2m
KWF298-7006	Kent energy saver flue kit 4.2m
KWF298-7354	Kent sloping ceiling flue kit 4.2m

Extra flue components available

Model No.	Description
KWF298-6033	Kent single length stainless steel flue 150 x 1200mm
KWF298-6022	Kent stainless steel flue reflector
KWF298-6029	Kent stainless steel flue twin pack 150mm
KWF298-6049	Kent black stainless steel flue twin pack 150 x 1200mm
KWF298-6051	Kent floor penetration 200/250mm diameter
KWF298-6053	Kent 360 degree flue pipe guard
KWF298-6328	Kent stainless steel hat and cowl
KWF298-6614	Kent extension flue 150-200-250 - 1200mm
KWF298-7025	Kent galvanised flue 200 x 1200mm
KWF298-7026	Kent galvanised flue 250 x 1200mm
KWF298-7351	Kent black flue 150 x 1200mm

FREESTANDING WOOD FIRE INSTALLATION

To adequately install a Kent freestanding wood fire the following items are required: an assembled wood fire, a floor protector, a flue system and a suitable flashing system for flashing the roof penetration.

An insulating floor protector is not required for the Kent freestanding wood fire, but a single layer ash floor protector of non-combustible material must be used. The floor protector must extend under the appliance and not less than 300mm in front of the fuel-loading and ash removal openings. The width of the floor protector shall not be less than the width of the appliance and shall extend not less than 200mm from each side of any ash removal or fuel-loading openings.

Select a location for the wood fire, considering the minimum clearances required (Refer Fig.1, table 2,).

Place the wood fire into the desired position and plumb for the ceiling and roof penetrations. Allow for 150mm diameter flue pipe, 200mm diameter inner casing and 250mm outer casing. Check the proposed route of the flue to ensure it is clear of roof trusses and rafters in the ceiling space or other obstructions. It may be necessary to move the location of the wood fire to ensure this.

Once the location is confirmed, the wood fire must be restrained against movement due to earthquakes. The Kent freestanding wood fire is restrained by fixing the wood fire to the floor with two bolts of 6mm minimum diameter through the holes provided in the plinth base, through the floor protector and floor. For solid concrete floors, use 8mm DYNABOLTS® or similar, with a minimum depth of engagement into the floor of 50mm.

STANDARD FLUE INSTALLATION

Cut a 260mm square hole for the passage of the flue and casings through the ceiling. Trim timber as necessary and reframe to fix 250mm outer flue casing at ceiling height.

Extend plumb line up to roof and cut a hole for the passage of the 250mm flue casing to pass out through the roof.

Position starter section of 250mm Ø galv flue casing with swaged end up and bottom flush with the underside of the ceiling. Fix in position with adequate screws fitted from inside the flue through to the framing of the 260mm square opening in the ceiling at the 4 intersecting points. Back off each screw 5mm so each fixing point has a 5mm gap between 250mm Ø flue casing and 260mm timber framed hole.

Start with the black sections of s/s flue. Join the required number of 150mmØ flue pipes together by inserting the swaged end of the upper piece into the plain end of the lower piece so the flue will terminate in the desired position (See Fig.2). Drill and fix each length with 3 stainless steel rivets or self-tapping screws. It is important that each flue joint is sealed with commercially available flue sealing compound, including the join between fire and first section of flue pipe.

Before fitting the flue to the fire, place the ceiling plate over fire spigot ensuring it is the right way up.

The 150mm Ø s/s flue sections can either be lowered from the top fully assembled onto the fire, or fed up from the bottom a length at a time ensuring all joints are sealed and fixed properly.

Slide the 200mm Ø inner casing/s into place crimped end up, between the outer casing and the 150mm Ø flue pipes. Slide down so the bottom flue spacer of the 200mm Ø section sits on the crimped seat of the 250mm Ø starter flue casing. Extend the 200mm Ø flue casing/s up until it is through the roof and between 200mm and 600mm from the top of the 150mm Ø flue that is finished in the desired position. Trim flues as required.

Extend up 250 Ø outer casing/s as required noting that the slip section supplied with the standard flue kit is the last casing to be added this section is adjustable slide in position and secure so the top of this section is 180mm below the top of the 150 Ø flue.

Fit a suitable flashing over the flue and roof penetration hole to flash the outer casing to the roof. Seal and fix flashing to roof and outer casing with an appropriate waterproof seal.

Place the top flue spacer bracket in position and tighten. Slide weather cowl over flue pipe until it sits firmly on spacer bracket. Fit the rain hat cowl. NOTE: it must be removable for cleaning.

Where the flue terminates more than one full section above the roof penetration, it must be restrained with guy wires or bracing support bars for stability in high wind conditions.

NOTE: The flue pipe shall extend not less than 4.6m above the top of the floor protector.

The flue cowl must be at least 0.6m above the highest point of the roof, if within 3 metres of the ridge. The flue cowl must be at least 1m above the roof penetration if more than 3 metres from the ridge (Refer Fig. 2).

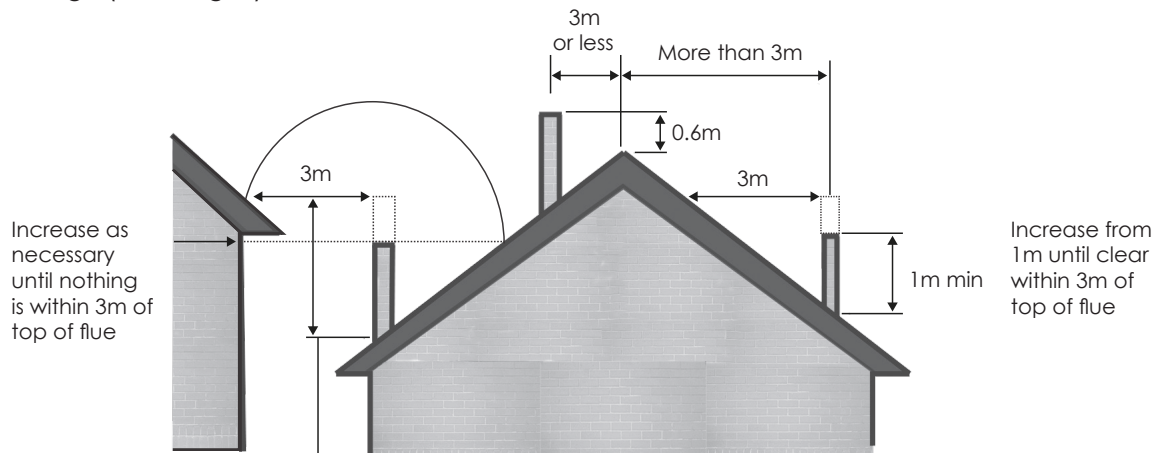

FIG. 2

No part of a building, or any adjacent object, may be above flue in a circular area of 3 metres from the flue exit.

These heights are given as a minimum, and in actual practice the presence of surrounding structures, trees, fences, etc. may necessitate additional flue height for satisfactory performance.

FOR MORE INFORMATION, REFER TO THE INSTALLATION INSTRUCTIONS INCLUDED WITH THE FLUE KIT.

Before the wood fire is used, ensure that a Compliance Certificate (supplied by a Registered Installer and/or Territorial Authority Inspector) is obtained for the user. We encourage initial demonstrations on how to light and operate the fire to ensure the user can confidently operate the fire for safe and efficient performance.

DOOR HANDLE AND DOOR

The door handle is pre-fitted and should not require any adjustment on assembly of the fire.

To ensure the door is shutting correctly cut a plain piece of paper about 50mm wide and place between the open door and the door frame. Close the door and try to pull the piece of paper out. If the paper can be freely pulled out, the door will need to be adjusted so when the door and handle is in the locked closed position pressure is applied to the paper strip ensuring the door is sealed correctly.

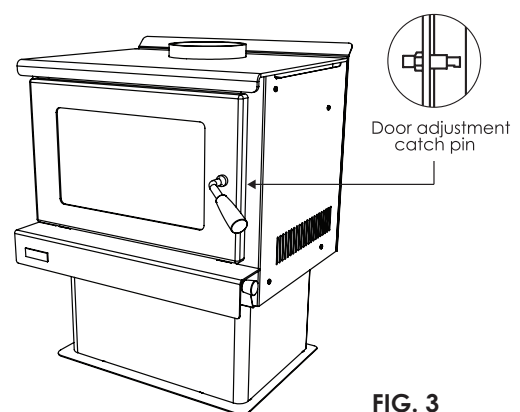

FIG. 3

If the handle has too much sideways movement the back nut on the hinge screw will need to be released. Tighten the hinge screw with an Allen key until the desired movement is achieved (not too tight, not too loose), then re-tighten the back nut to hold screw in position.

Any adjustment required to maintain the correct fit of the door is made at the door catch pin on the right side of the door lip. To adjust the fit of the door catch, loosen the lock nut and turn the catch pin to loosen or tighten the fit. Re-tighten the lock nut (Refer Fig.3).

TOPOGRAPHY OF THE LAND

Given that the topography of the land and atmospheric conditions vary considerably from house to house, it is possible for a wood fire flue to comply with the minimum requirements set out in Fig.2 but still fail to extend upward far enough to establish ambient updraft. It is not uncommon for fireplaces in houses that are surrounded by hills or trees, or that are located by large bodies of water to need more flue height than the minimum required by code.

WIND CONDITIONS

Wind causes pressure changes inside as well as outside a house. The design of the house can influence the pressure environment around and in your home, the effect of wind on the home can be complex and unpredictable. Care needs to be taken to ensure the flue termination is in a good clear position. Your installer should be able to give advice on the best flue termination position for your situation. Problems associated with wind noise or draft are almost never caused by the wood fire itself and in general a flue that penetrates the roof near the peak and is more than 600mm above the ridge is unlikely to be affected by wind.

PRESSURE DIFFERENTIAL, VENTING AND EXTERNAL AIR INTO THE BUILDING

Negative house pressure is a common problem that can cause wood burning appliances to have trouble lighting and performance issues, in some cases causing smoke to be spilled back into the room. Kitchen and bathroom exhaust fans air-conditioning units, and well-sealed, insulated homes are more likely to have a negative pressure problem. Larger homes with multiple levels are also likely candidates, however any house can have a negative pressure problem. Care needs to be taken at the design or installation stage to ensure the building has adequate ventilation to ensure draft in the flue system is always to the outside.

FIREWOOD

Modern clean burning wood fires are designed to burn seasoned dry natural soft wood only, such as pine.

The moisture content of the wood affects the performance of your wood fire greatly. The most important thing you can do to operate your wood fire correctly is to use the correct seasoned dry wood. All types of seasoned natural wood will burn in your wood fire, but your wood fire is tuned to burn seasoned clean, dry soft woods.

Fossil fuels such as coal are not suitable. Do not burn garbage or large quantities of paper, cardboard or similar materials. Do not use chemically impregnated timber, reclaimed wood from wet environments and do not use drift wood. These corrode the components of the wood fire and flue systems reducing the life of your wood fire.

Important: Kent freestanding wood fires with a wood box are designed for temporary wood storage only. Store your "ready-to-use" firewood away from the wood fire while in use. If firewood is placed near or under the wood fire it must be there for reloading use only, and be rotated through often to stop the firewood becoming tinder dry and a potential fire safety hazard.

Handy Hint: When preparing firewood for use, store it in an open shed exposed to wind. If stored in an enclosed garage or shed it will take longer to dry out.

DO NOT BURN TREATED TIMBER
DO NOT BURN WET OR UNSEASONED WOOD

OPERATION

Thank you for purchasing a Kent wood fire. Used and maintained correctly, it will provide you with many years of warmth in your home. Kent wood fires have been the main source of heating for many Kiwi homes, for over 40 years.

Please ensure your installer completes and signs the warranty registration card in this booklet. We encourage you to read the warranty conditions and draw your attention to improper fuel use.

Important: Read FIREWOOD information on page 7 before use.

LIGHTING

On initial light up, the presence of smoke may be noticed. This is normal and will dissipate quickly. **DO NOT BURN YOUR WOOD FIRE TOO QUICKLY TO BEGIN WITH.** Allow several small fires to build up a layer of ash in the wood fire, and cure the paint before using maximum power.

1. Adjust the air control knob, until it is fully open.
2. Place several pieces of crumpled newspaper in the base of the firebox, and criss-cross with 8-10 pieces of dry split kindling. Stack several pieces of dry split firewood no greater than 30cm in length on top of the kindling.
3. Ignite the paper and leave the door slightly ajar (resting it on the latch). Let the fire establish itself for 4-5 minutes, then open the door and add some more pieces of wood. Do not leave the fire unattended during this process.
4. Close the door fully, but leave the air control fully open until the wood is well alight and burning brightly.

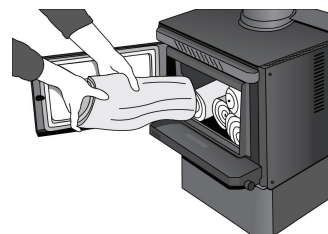

Note: It may be necessary in some cases to leave the door ajar for longer periods and use more small kindling in order to establish enough heat to warm up the flue. Only when the flue is sufficiently warm to create the necessary draft to maintain the fire may the door be fully closed. It may take trial and error to find a lighting procedure that suits your situation.

NORMAL OPERATION ONCE THE FIRE IS ESTABLISHED

The Kent wood fire requires fresh air for optimal burning, and this must come from outside the house. A normal house will allow enough air in through incidental openings to satisfy this. We recommend that a source of air be located near the wood fire for best performance. This can be simply a window that is left ajar while the wood fire is in use. If this is not possible, and the house is particularly air-tight, a vent may need to be installed next to the wood fire to provide the air required. Lack of air will lead to a wood fire that is hard to light and get going, or in bad cases, to smoke spilling back into the room.

While an air control is fitted, it is recommended that, for the cleanest operation, this is left fully open and the amount of heat generated is adjusted by the amount of fuel that is used. The heater burns cleanest when it is running at a high rate.

Once the fire is well established, the output can be regulated by the amount of wood that is used.

To reload the fire, open the air control fully, and then open the door. Note that the fire burns hottest at the front of the firebox and so there may be unburnt wood at the back when it comes time to reload. This is normal. Rake through the contents to move any unburnt wood forward and then place the desired amount of wood into the firebox. Close the door.

The view of the flame through the glass door will give you the best indication of how your wood fire is performing. In order to accomplish maximum combustion performance, the fire should give a rolling, boiling flame pattern. At reduced setting the flame will be slower.

For all practical purposes, the air control should be fully open when there is unburnt wood in the wood fire. Fire holding periods may be increased by turning down the air control, this is at the cost of greater emissions and creosote production. At low settings, creosote may condense on

the glass, reducing the visibility of the fire. The best indication that the fire is operating correctly is that the glass remains clean, without build-up of black or brown deposits. Some whitish bloom on the glass is normal and does not generally indicate a fault in operation.

The way you burn your wood fire will also determine what is happening up the flue. Continued burning at high rates with a good clean flame will minimise soot and creosote deposits in the flue.

FOR FIRST FIRE

All Kent wood fires are finished in a high temperature quality stove paint. The paint has not been fully cured until it has been heated. If the fire is run too hot, too fast, the paint will burn off before it has had a chance to fully bond to the steel. When the fire is first used, it should be run on "low" for the first 4 hours to allow the paint time to fully cure.

CLEANING OUT THE WOOD FIRE

Your wood fire should require minimum cleaning. If the wood fire is operated correctly, and according to the instructions most of the ash will be consumed by the fire and a bed of ash will be maintained that does not build up to any great extent.

If you find that you have to clean out ashes every day or so, it indicates that the wood fire is not being operated correctly. Either excessively wet wood, unseasoned wood or foreign materials are being burnt, or the air control is being turned down too much.

Don't clean out the firebox completely during the heating season. Leave about 25mm of ash in the bottom of the firebox after cleaning. These ashes in the bottom of the wood fire assist the burning process, by insulating the firebox and allowing air circulation under the fire bed.

When emptying ashes use a metal container with a tight fitting lid. Do not use this container for any other purpose. The closed container of ashes should immediately be taken outdoors to a location well away from any combustible materials, pending final disposal. If the ashes are to be disposed of by burial in the garden or otherwise locally dispersed, they should be retained in the container until they are completely extinguished and cold. This may take several days.

CREOSOTE FORMATION AND NEED FOR REMOVAL

We recommend the flue of your wood fire is inspected before use at the start of each heating season and also periodically during the season. When you are able to operate the wood fire without creating creosote deposits, the interval between inspections may be increased, but the flue must always be inspected and cleaned at least once a year.

The flue should be swept by a professional chimney sweep to remove any build-up of creosote and soot. A professional sweep should also advise of any problems that may be detected in the inspection of the flue and offer advice on any repair and replacements. Your Kent wood fire requires minimal maintenance, and will keep its good looks for a long time with just a little attention.

RUST

Your Kent wood fire is manufactured using steel components. Due to the extreme operating temperatures and inconsistent fuel that wood fires are subjected to, a small amount of rusting over time on the inside of the fire box is normal. Without adequate care it is realistic to expect that the steel fire box and internal components will show signs of corrosion.

All steel, including stainless steel requires a level of care and protection to retain its appearance. No steel is immune to corrosion and neither is it maintenance free.

If your fire box and internal components are showing signs of more than a small amount of surface rust, and a water leak can be eliminated, moisture in the fire box can only be due to the environment the fire is installed in, and or, through the fuel that is being used.

Seasoned wood is a very vague term as it depends on how the wood has been kept and stored since it was felled. Just because a log was felled 2 years ago, does not mean that it is seasoned enough to be considered "good wood" and suitable fire wood.



Visual inspection takes a lot of experience to tell if a piece of wood is sufficiently seasoned and dry enough to be "good wood". Wet or unseasoned wood is not good for heat output as it produces more smoke. The moisture released from wet wood combined with the smoke is in most cases corrosive.

Purchasing a moisture meter is an inexpensive way to test how dry your wood is. Always test a new load of fire wood to gauge if it is "good wood". This will help determine how your fire wood needs to be handled - use now, to be aired or stored for next season.

REPLACEMENT PARTS

Replacement parts must be original Kent parts. Maintenance required should be carried out by qualified service people. Please consult your Kent retailer for their details. The wood fire should not be modified in any way except in accordance with instructions supplied by Kent.

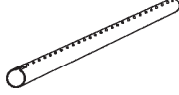
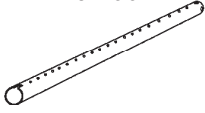
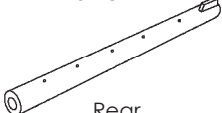
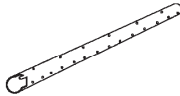
KENT AIR TUBES

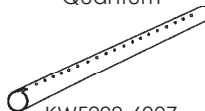
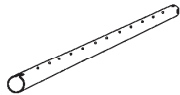
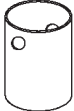
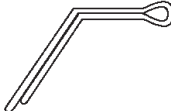
<p>Kiwi Rad II, Astron, Firenze, Cardrona, Oxford & Benmore</p>  <p>KWF299-6903</p>	<p>Tui Rad</p>  <p>KWF299-6986</p>	<p>Barker II</p>  <p>Rear KWF299-6992</p>
<p>Haast, Aspiring, Murchison & Tilefire Max CA II</p>  <p>Top front KWF299-6905</p>	<p>Signature</p>  <p>KWF299-6908</p>	<p>Quantum</p>  <p>KWF299-6907</p>
 <p>Top rear KWF299-6906</p>	<p>All Fires</p>  <p>Air Tube Spacer KWF299-6257</p>	<p>All Fires</p>  <p>Air Tube Pin KWF299-6900</p>



The air tube in your Kent wood fire is an important part of the appliance and helps ensure a clean, efficient and controllable burn. However, air tubes are a consumable item and are designed to be replaced as they are likely to degrade with use due to the exposure to the extreme heat of the fire.

The life of the air tube will depend on what is burnt in the fire, how hot the fire usually burns and also the ash level. If the ash level is allowed to build up. It means hot embers are in closer proximity to the tube, increasing the temperature exposure. Keep ember levels to the recommended maximum height of 3cm below air tubes.

Replacing air tubes:

1. Remove bricks from both sides
2. Remove the pin from the end of the old tube
3. Slide tube to one side; this will release the opposite end
4. Pull released end up and towards the door and remove
5. Reverse process for new tube

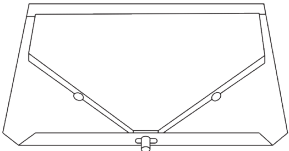
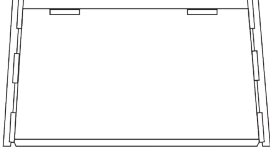
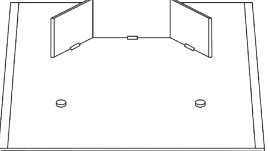
KENT Baffles

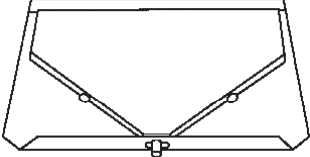
<p>Tui Rad</p>  <p>Dimensions (mm): 488 x 238 KWF299-7044</p>	<p>Kiwi Rad II, Astron, Firenze, Cardrona, Oxford & Benmore</p>  <p>Dimensions (mm): 400 x 208 KWF299-6190</p>	<p>Haast, Aspiring, Murchison & Tilefire Max CA II</p>  <p>Includes Promat bricks Dimensions (mm): 480 x 200 KWF299-7043</p>
<p>Signature</p>  <p>Dimensions (mm): 495 x 190 KWF299-6189</p>	<p>Quantum</p>  <p>Firebox requires 2 baffles Dimensions (mm): 529 x 157 KWF299-6177</p>	<p>Barker II</p>  <p>Dimensions (mm): 488 x 314 KWF299-6993</p>





The baffle in your Kent wood fire is an important part of the appliance and helps ensure a clean, efficient and controllable burn. However, baffles are a consumable item and are designed to be replaced as they are likely to degrade with use due to the exposure to the extreme heat of the fire.

The life of the baffle will depend on what is burnt in the fire and how hot the fire usually burns.

Replacing baffle:

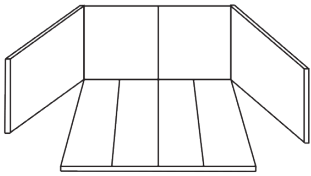
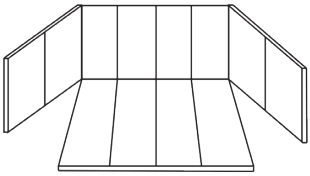
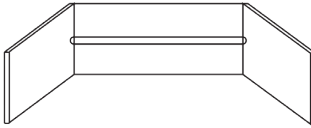
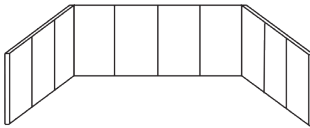
1. Remove front air tube by pulling locking pin out of air tube spacer slide ring on the left top side. Slide spacer ring to the right and slide air tube horizontally to the left. Right hand side of the air tube will drop out of the keyed side.
2. Swing air tube out through door.
3. Lift baffle plate up off side support rails and pull forward 40mm. Push one side up as high as you can while letting the other side drop over the side support rail.
4. Keep at a 30° angle and remove it through the door.
5. Reverse process to install new baffle. And air tube.
6. Ensure baffle is sitting firm against back.

KENT FIRE BRICKS

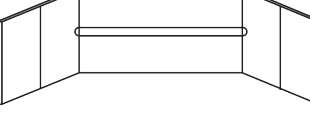
<p>Kiwi Rad II, Cardrona, Oxford & Benmore</p>  <p>Dimensions (mm): 4 - 220 x 115 x 28 2 - 221 x 221 x 25 2 - 229 x 220 x 25</p> <p>KWF299-6123</p>	<p>Astron & Firenze</p>  <p>12 per pack Dimensions (mm): 220 x 115 x 28</p> <p>KWF299-6122</p>
<p>Tui Rad</p>  <p>Dimensions (mm): 2 - 498 x 100 x 25 2 - 260 x 255 x 25</p> <p>KWF299-7038</p>	<p>Quantum</p> 
<p>Haast, Aspiring & Murchison</p>  <p>Dimensions (mm): 2 - 240 x 190 x 25 2 - 245 x 177 x 25</p> <p>KWF299-7089</p>	<p>Signature</p>  <p>9 per pack Dimensions (mm): 220 x 115 x 28</p> <p>KWF299-7193</p>
<p>Tilefire Max CA II</p>  <p>Dimensions (mm): 2 - 205 x 176 x 25 4 - 180 x 176 x 25</p> <p>KWF299-7040</p>	<p>Barker II</p>  <p>Dimensions (mm): 1 - 490 x 140 x 25 1 - 490 x 110 x 25 2 - 355 x 190 x 25 2 - 330 x 190 x 25</p> <p>KWF299-7039</p>

The fire bricks in your Kent wood fire are an important part of the appliance and helps ensure a clean and efficient burn. However, fire bricks are a consumable item and are designed to be replaced as they are likely to degrade with use due to the exposure to the extreme heat of the fire.

The life of the fire bricks will depend on what is burnt in the fire and how hot the fire usually burns and also any damage sustained from wood not being positioned correctly.

At the risk of damaging the fire box, fire bricks should be replaced when they are damaged enough that they no longer remain in place and cannot perform their intended function. Fire bricks which are only cracked but still remain in place do not need to be replaced and are safe to use.

Note: For all other fire parts please contact your Kent dealer.

WARRANTY

Please read this warranty carefully and keep it, and your purchase receipt in a safe place. You must produce the required Kent product warranty registration information and proof of purchase in the event of any warranty repair being required.

WARRANTY TERMS & CONDITIONS

Kent agrees to replace, or repair as necessary any part of the appliance which is proven at the time of delivery, or within the warranty periods shown below to be defective through faulty materials or workmanship.

This warranty is for normal domestic use. Your Kent wood fire is warranted for up to 15 years, with the exception of the following parts; door glass, door & glass seals, fire bricks, flue, secondary air systems & baffle plates, which all have a 12 month (part only) warranty.

The warranty does not cover damage or failure due to incorrect or faulty installation, misuse, negligence, water damage, burning improper fuel or environmental conditions. Any unauthorised alteration, modification or substitution of any part of this appliance or use of this appliance not in accordance with the instructions supplied, will render this warranty void.

Your Kent wood fire must be installed in accordance with the manufacturers instructions and with the appropriate approved flue system. Installation must comply with applicable standards, regulations and local by-laws. Failure to do so will void any warranty offered in its entirety.

If the appliance needs repair and is installed outside the normal service area (25km) of the nearest authorised service agent the purchaser is responsible for any additional expenses incurred. In the event that an appliance needs to be replaced, the warranty does not extend to any consequential materials required or additional expenses incurred.

All claims against the warranty must be directed in the first instance to the store of purchase. Any repairs undertaken without the manufacturers authority will invalidate this warranty.

In order for the purchaser to obtain the protection of the 15 year warranty you must register the warranty registration by post or email within 30 days of installation. This extended fire box cover requires annual inspection and servicing by a qualified technician. If the 15 year warranty is not registered within in 30 days, the industry standard 10 year fire box warranty will apply subject to; proof of purchase, installation, servicing details and a warranty form being completed.



KENT PRODUCT WARRANTY REGISTRATION

For Kent extended 15 year fire warranty, please complete the following form and return within 30 days of installation to;

Aber Holdings Ltd
PO Box 10095
Te Rapa
Hamilton 3241
NEW ZEALAND

Or email to sales@aber.co.nz

Name:.....

Address:.....

Email:.....

Phone:.....

Model:.....

Serial Number:.....

Date purchased:.....

Purchased from:.....

Date installed:.....

Installed by:.....

Installer NZHHA, PGDB, or LBP registration number:.....

Consent Number:.....

Kent products are distributed by:
Aber Holdings Ltd T/A Aber,
Hamilton
Free Phone: 0800 161 161
Free Fax: 0800 163 163
www.aber.co.nz

Product specifications are at date of publication and are
subject to change without notice.
KWF299-7108-03/18



www.kent.co.nz